

01

Delikli köşe profili  
veya Köşe bandı +  
ABS Derz Dolgu Alçısı

ABS Derz Dolgu Alçısı

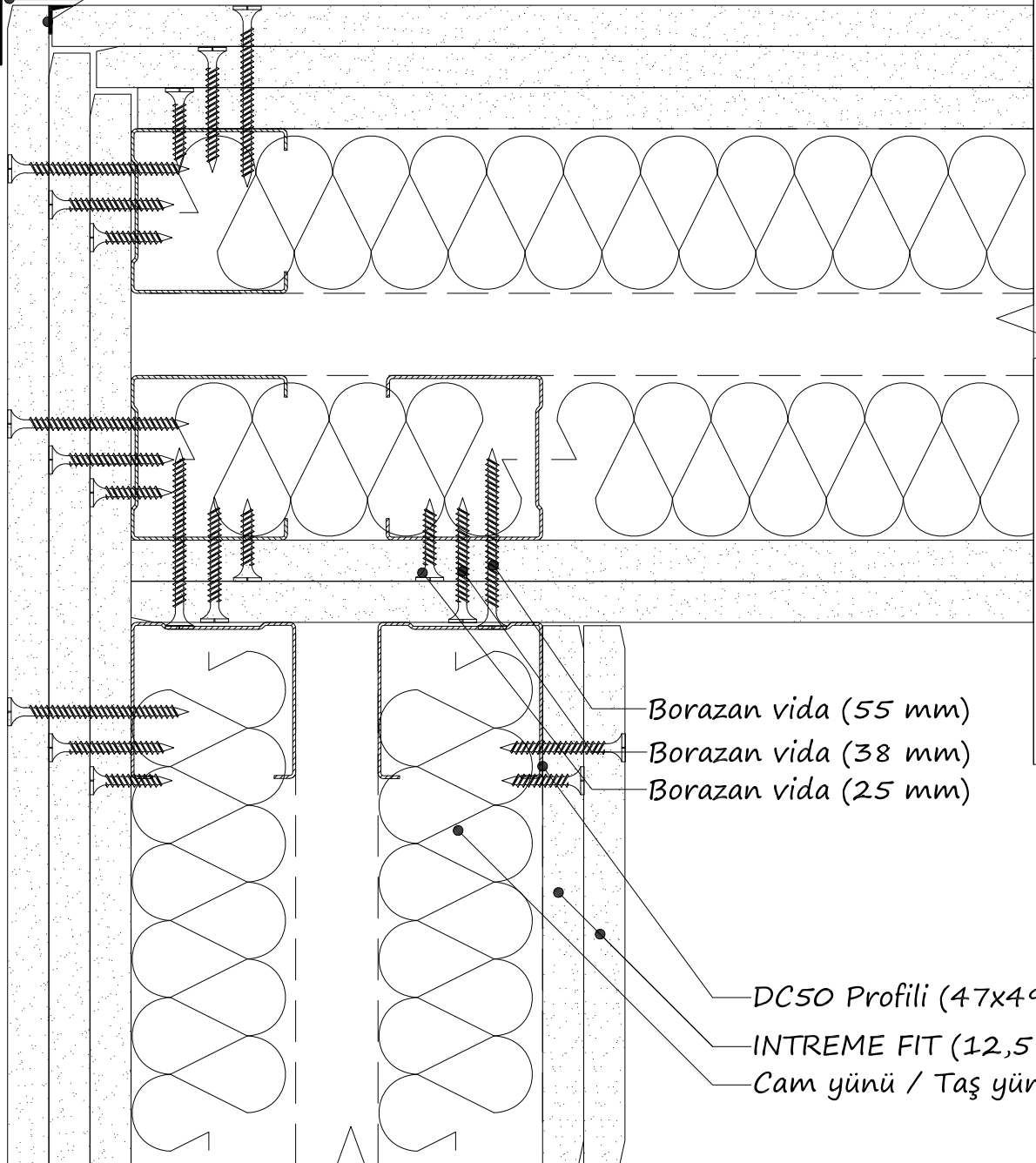

Borazan vida (55 mm)

Borazan vida (38 mm)

Borazan vida (25 mm)

DC50 Profili (47x49x47)

INTREME FIT (12,5 mm)

Cam yünü / Taş yünü

87

25

75

188

ABS ALÇI

<https://www.absalci.com.tr>

DETAY 01: ÇİFT İSKELET ASİMETRİK KAT  
Pafta Adı: INTREME FIT KÖŞE BİRLEŞİM PLANI  
(BAĞLANTISIZ)

Proje Numarası: ABS\_BD\_01\_02

Çizen: ABS Alçı Design Ofis

Ölçek: 1/2

Pafta: A4

02

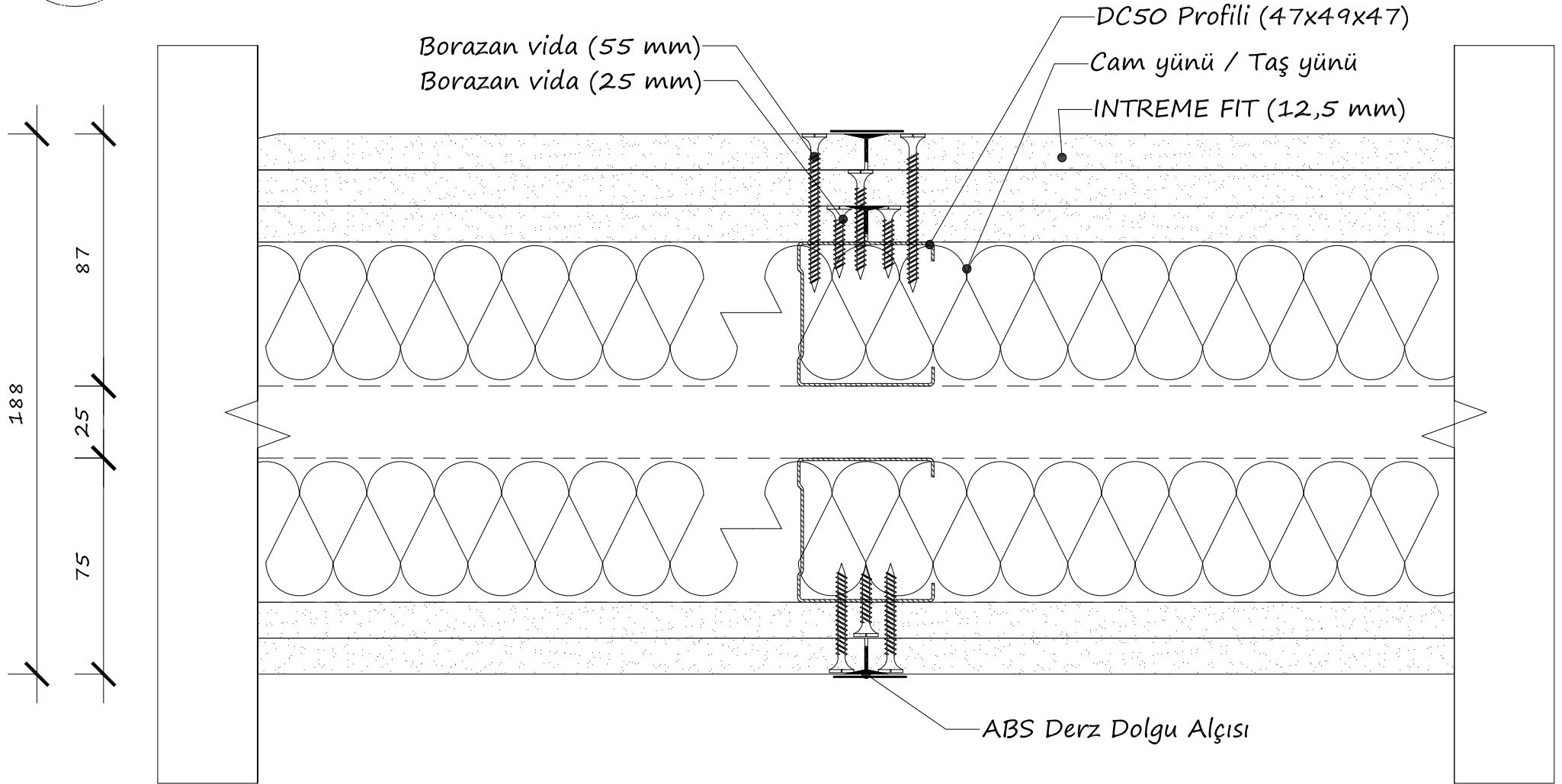

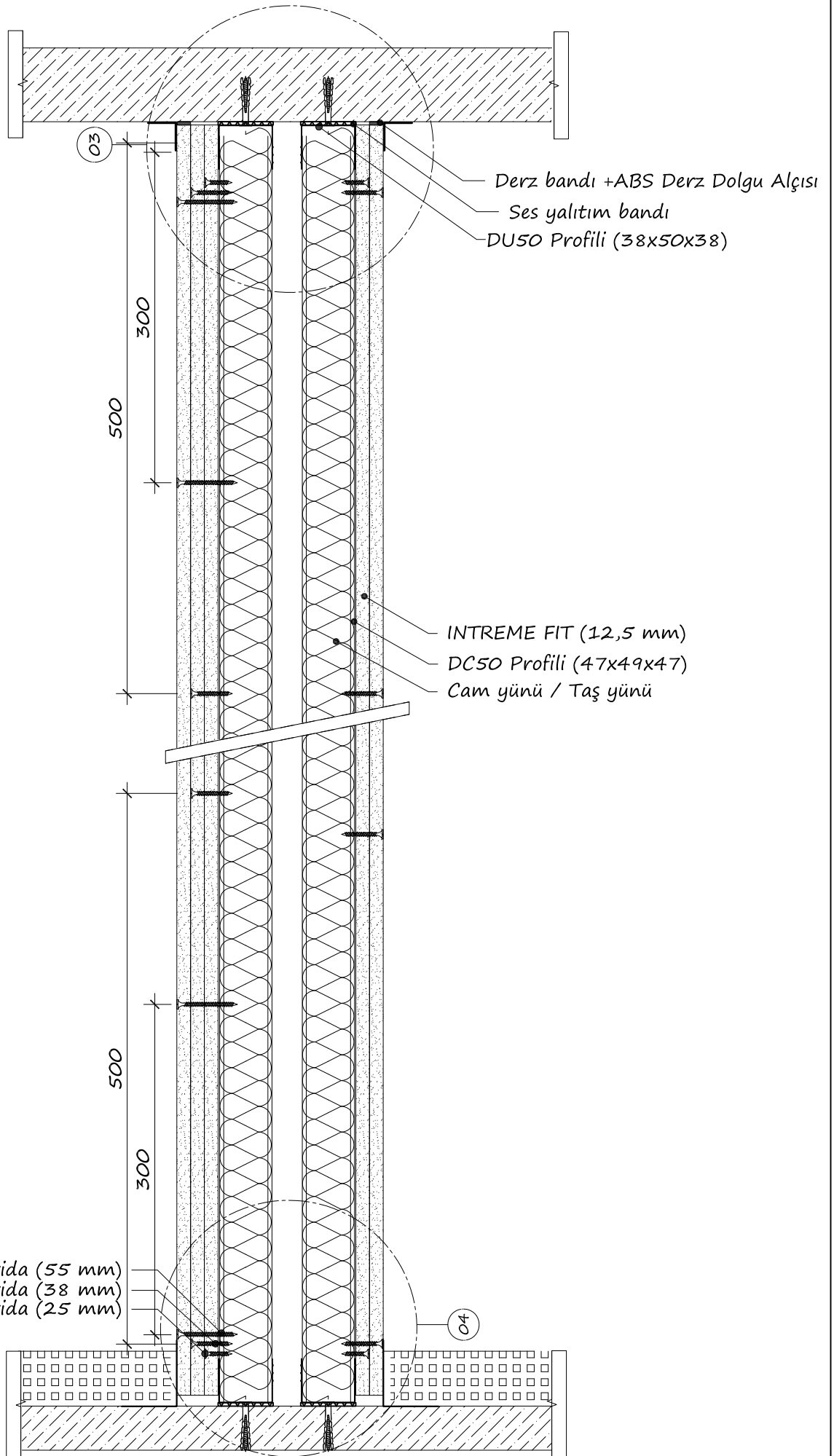

03

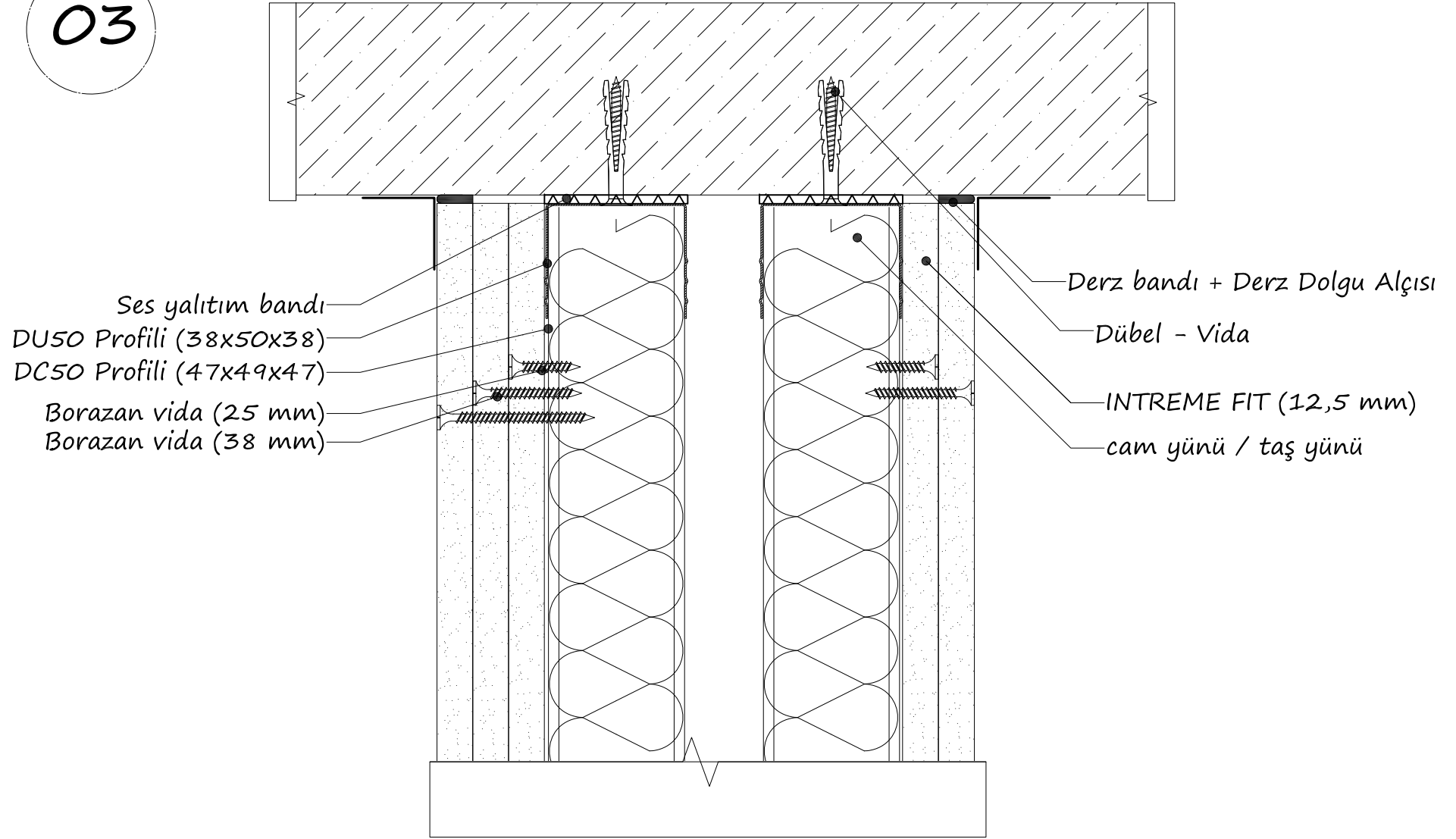

04

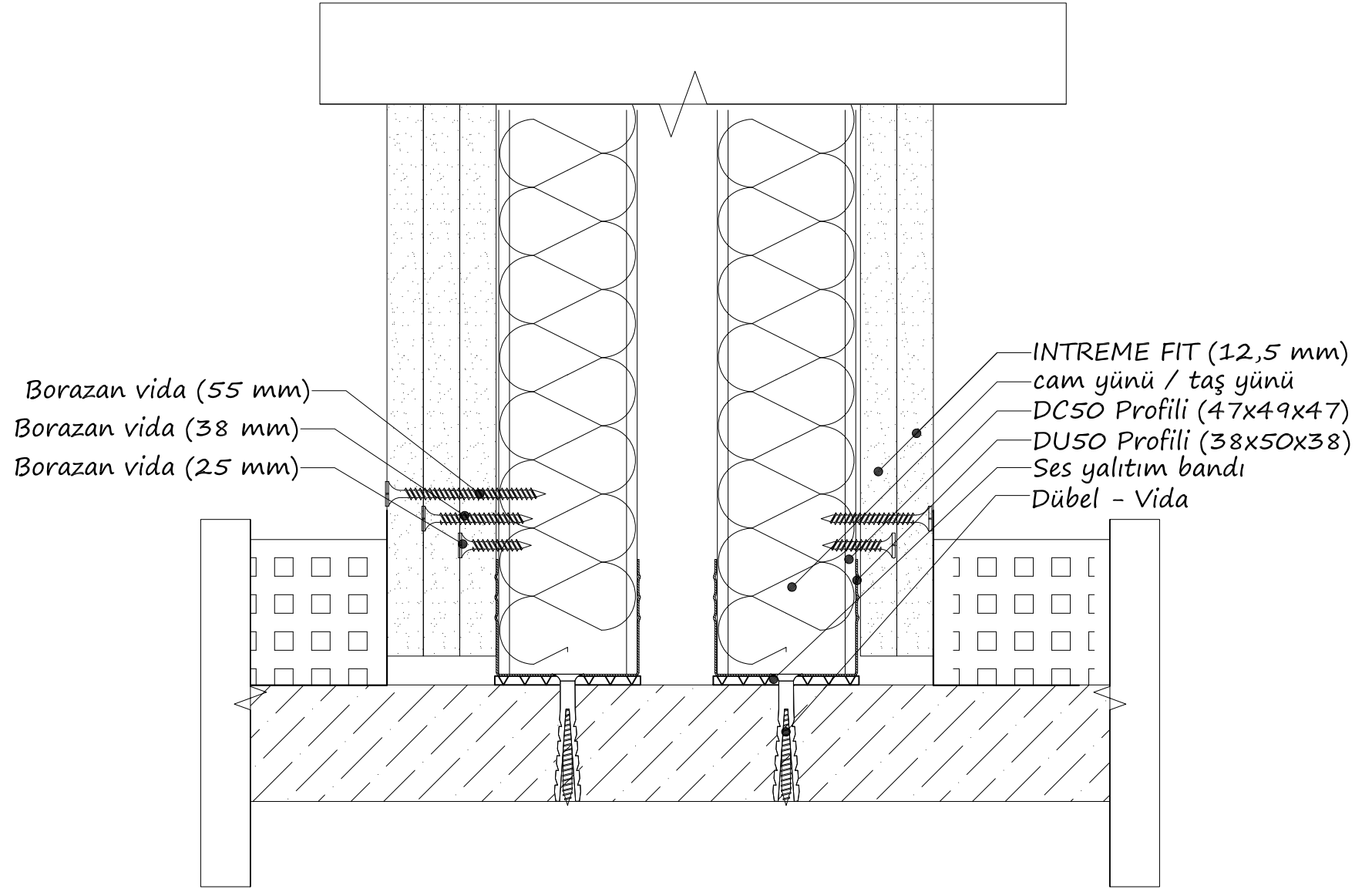

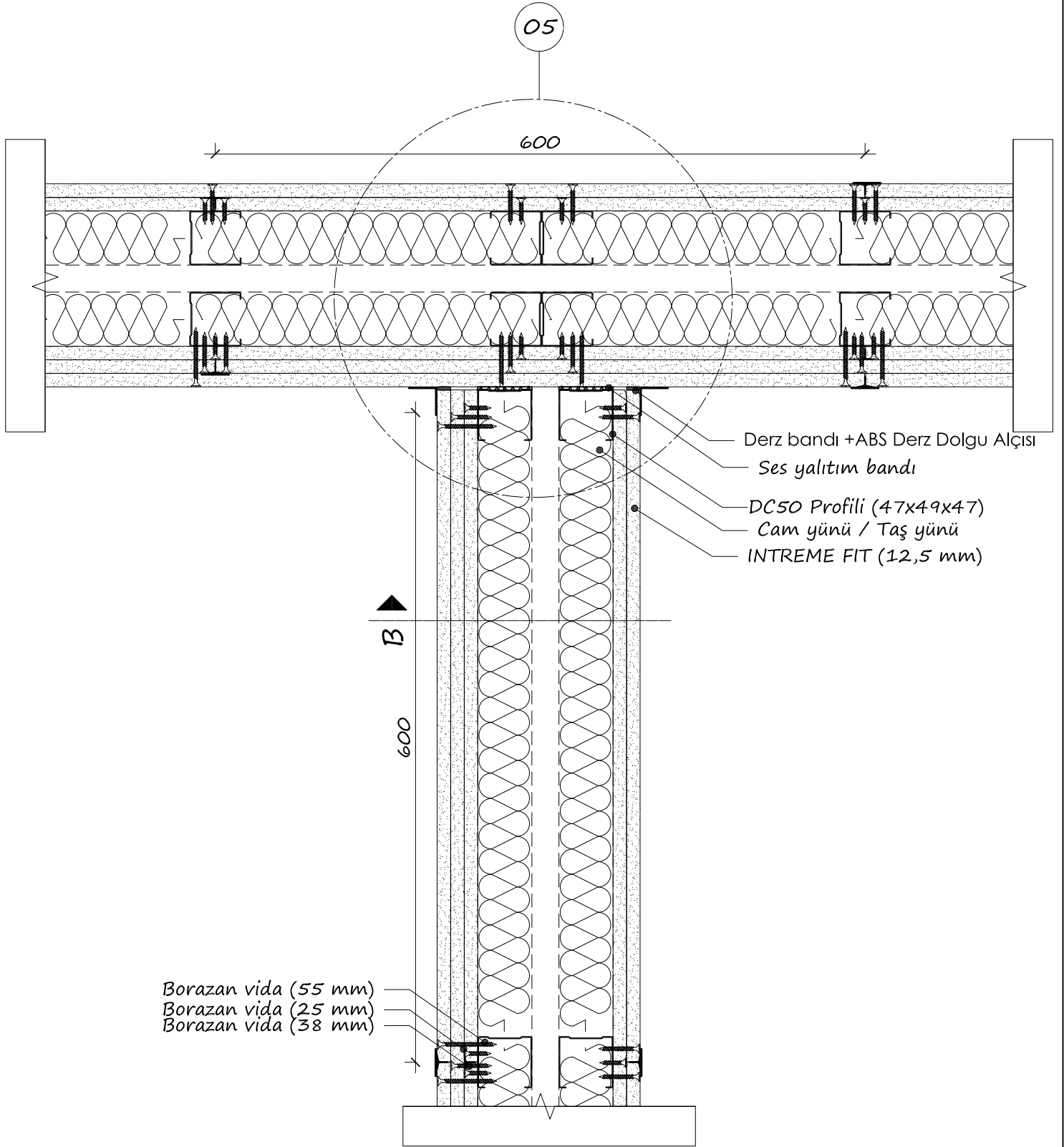





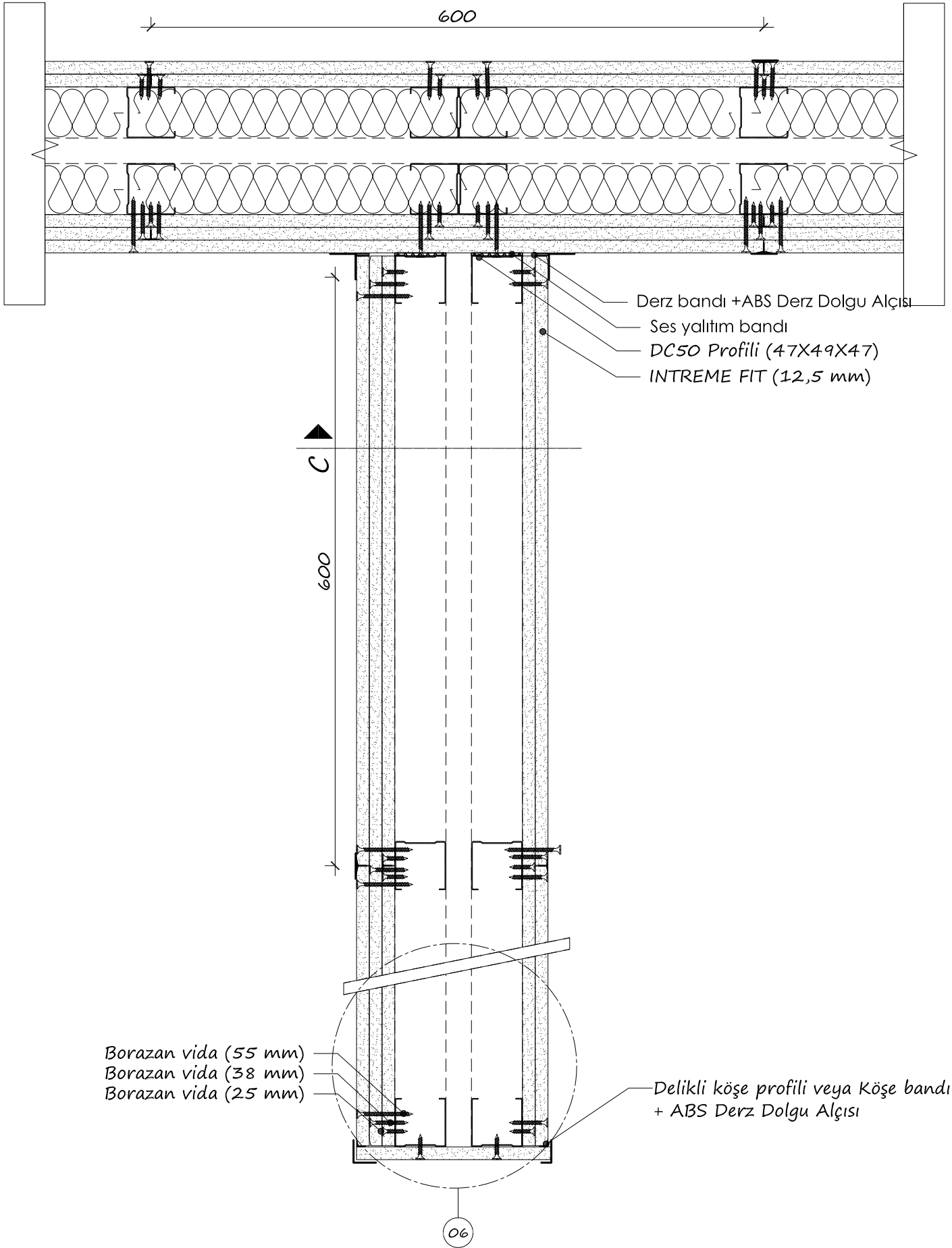

**ABS ALÇI**

<https://www.absalci.com.tr>

Pafta Adı: ÇİFT İSKELET ASİMETRİK KAT  
INTREME FIT DIŞ DUVAR (BAĞLANTISIZ)

Proje Numarası: ABS\_BD\_01\_09

Ölçek: 1/5

Çizen: ABS Alçı Design Ofis

Pafta: A4

06

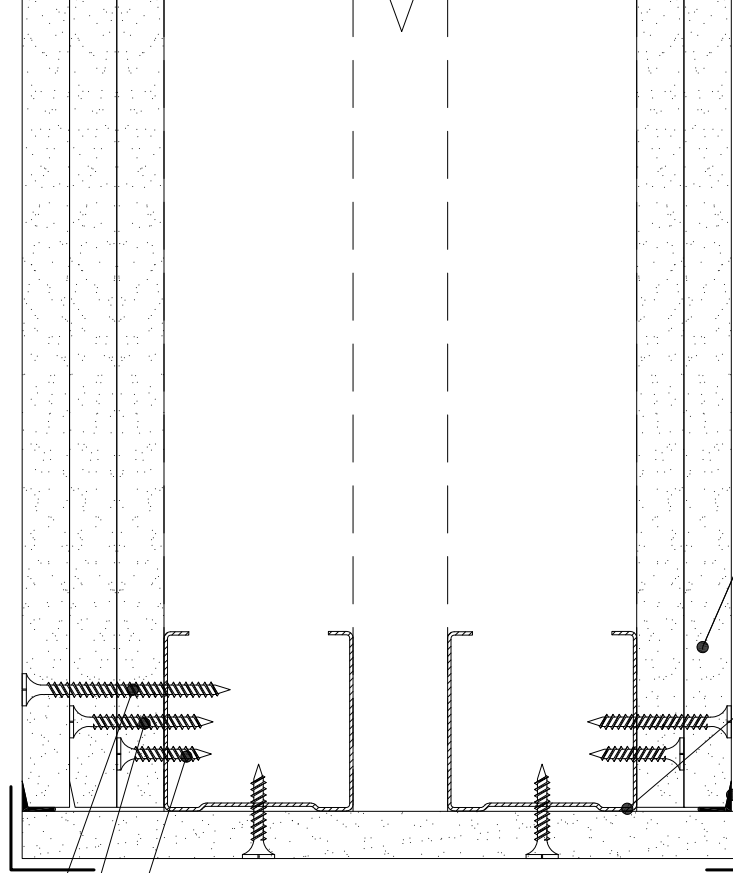
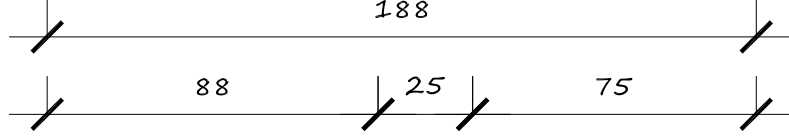

INTREME FIT  
(12,5mm)

DC50 Profili  
(47x49x47)

Borazan vida (55 mm)

Borazan vida (38 mm)

Borazan vida (25 mm)

Delikli köşe profili veya Köşe bandı  
+ ABS Derz Dolgu Alçısı

Derz bandı +ABS Derz Dolgu Alçısı

**ABS ALÇI**

<https://www.absalci.com.tr>

Pafta Adı: DETAY 06: ÇİFT İSKELET ÜÇ KAT INTREME FIT  
DIŞ DUVAR PLANI (BAĞLANTISIZ)

Proje Numarası: ABS\_BD\_01\_10

Çizen: ABS Alçı Design Ofis

Ölçek: 1/2

Pafta: A4

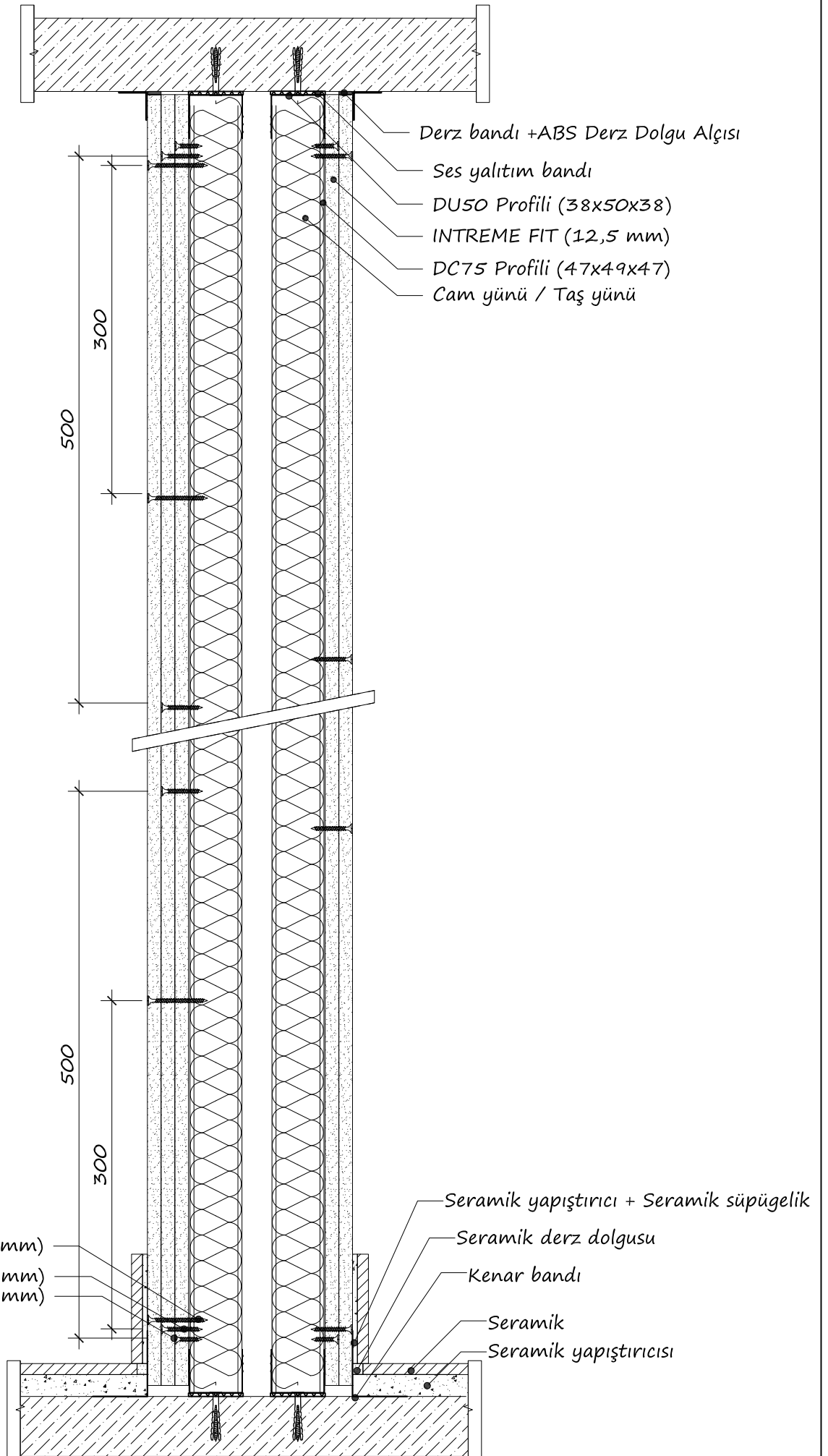

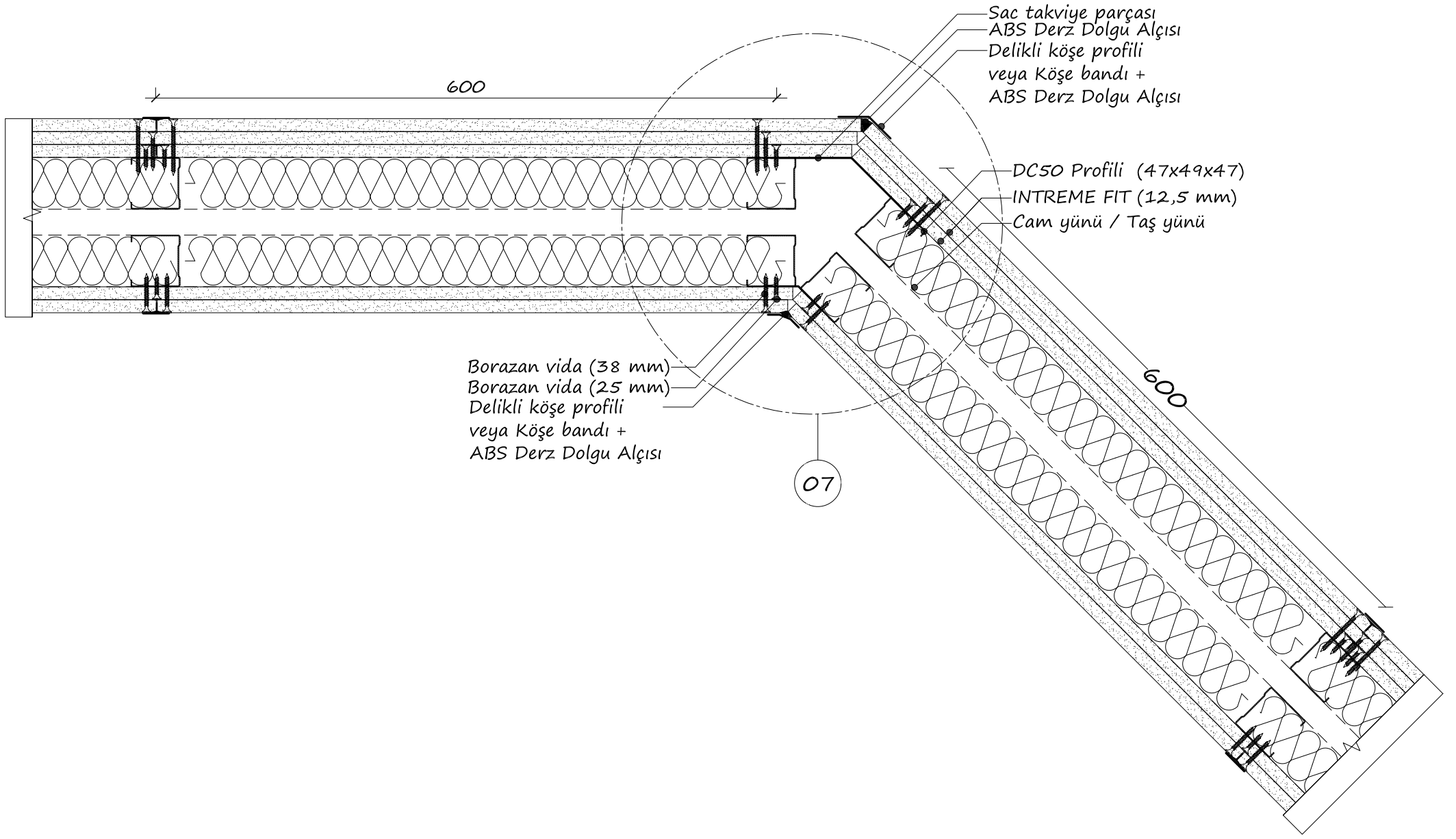

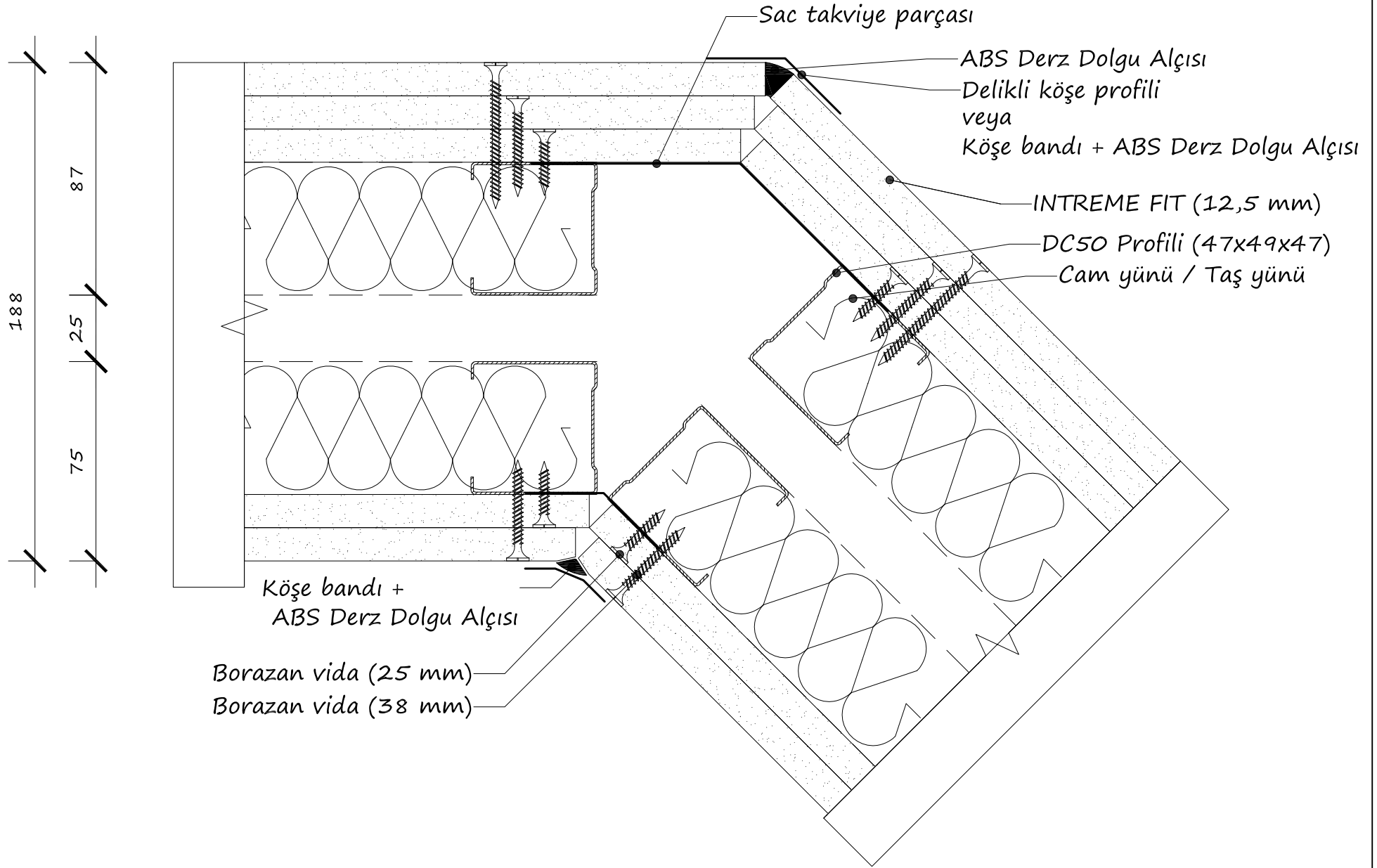

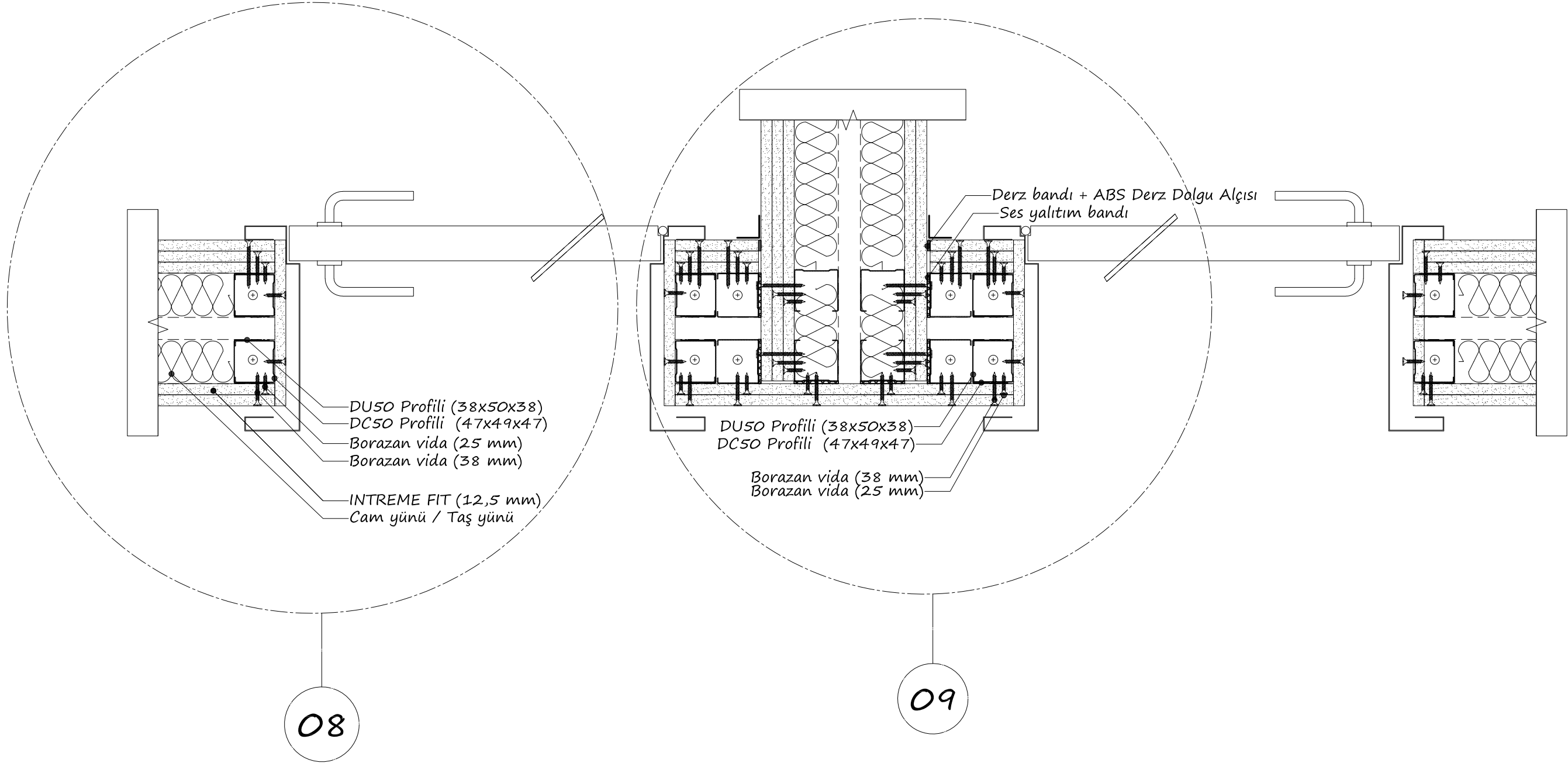

08

INTREME FIT (12,5 mm)  
DC50 Profili (47x49x47)  
DU50 Profili (38x50x38)  
Cam yünü / Taş yünü

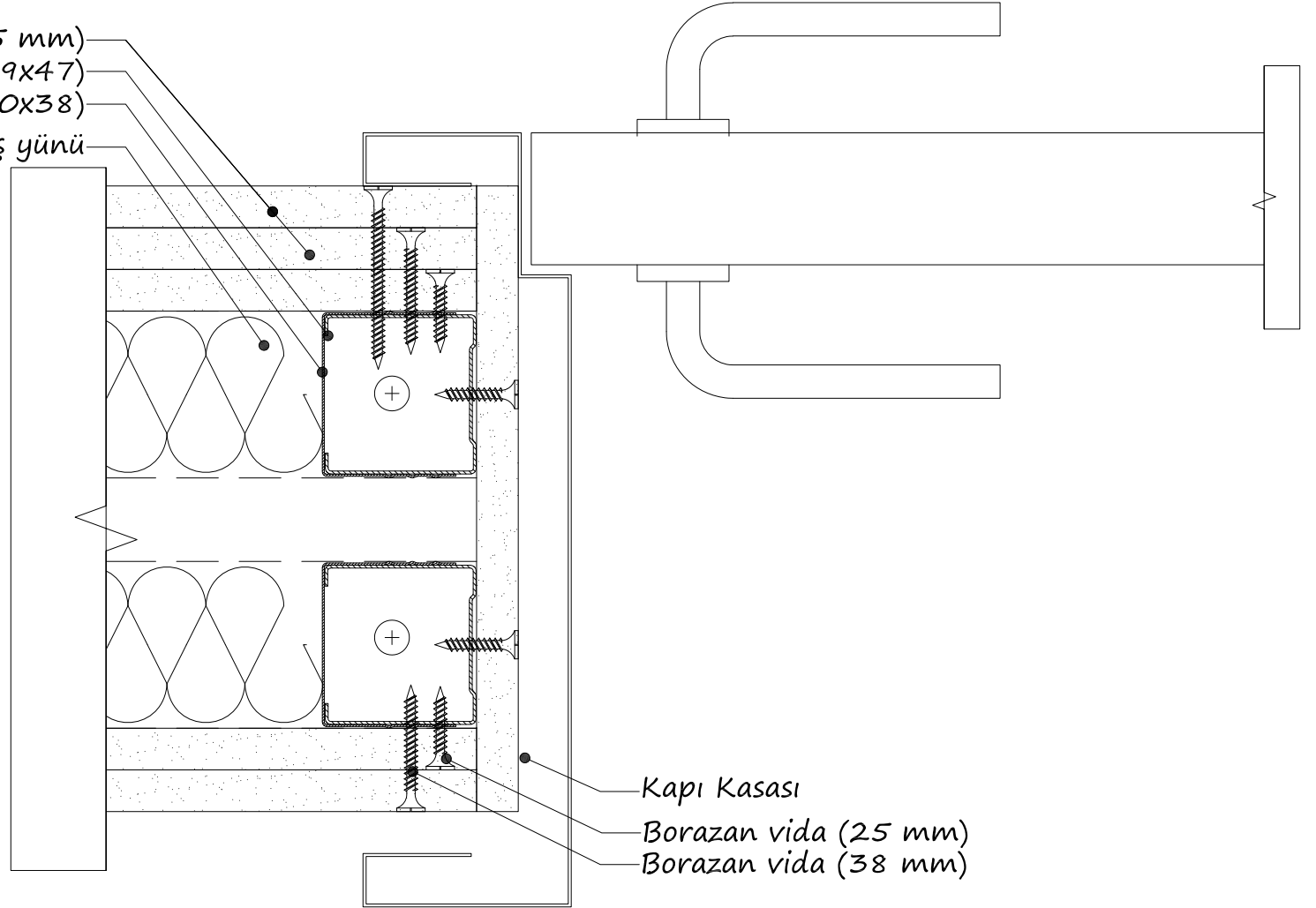

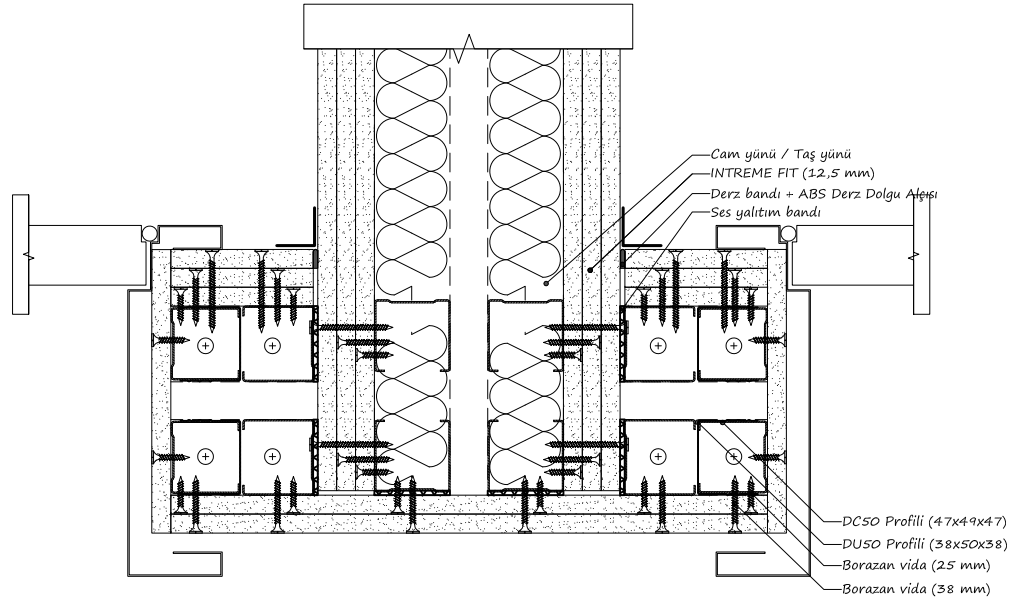



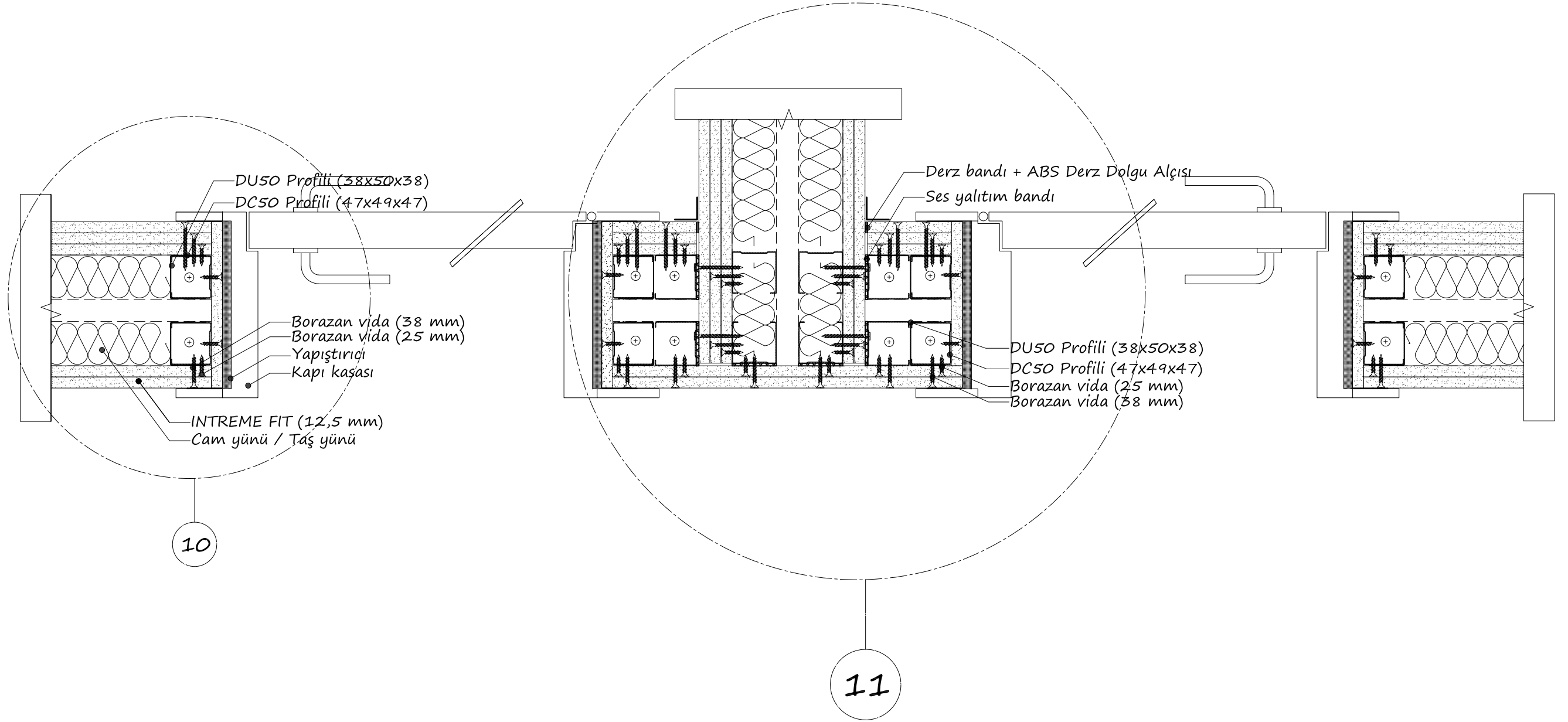

10

INTREME FIT (12,5 mm)

DC50 Profili (47x74x47)

DU50 Profili (38x75x38)

Cam yünü / Taş yünü

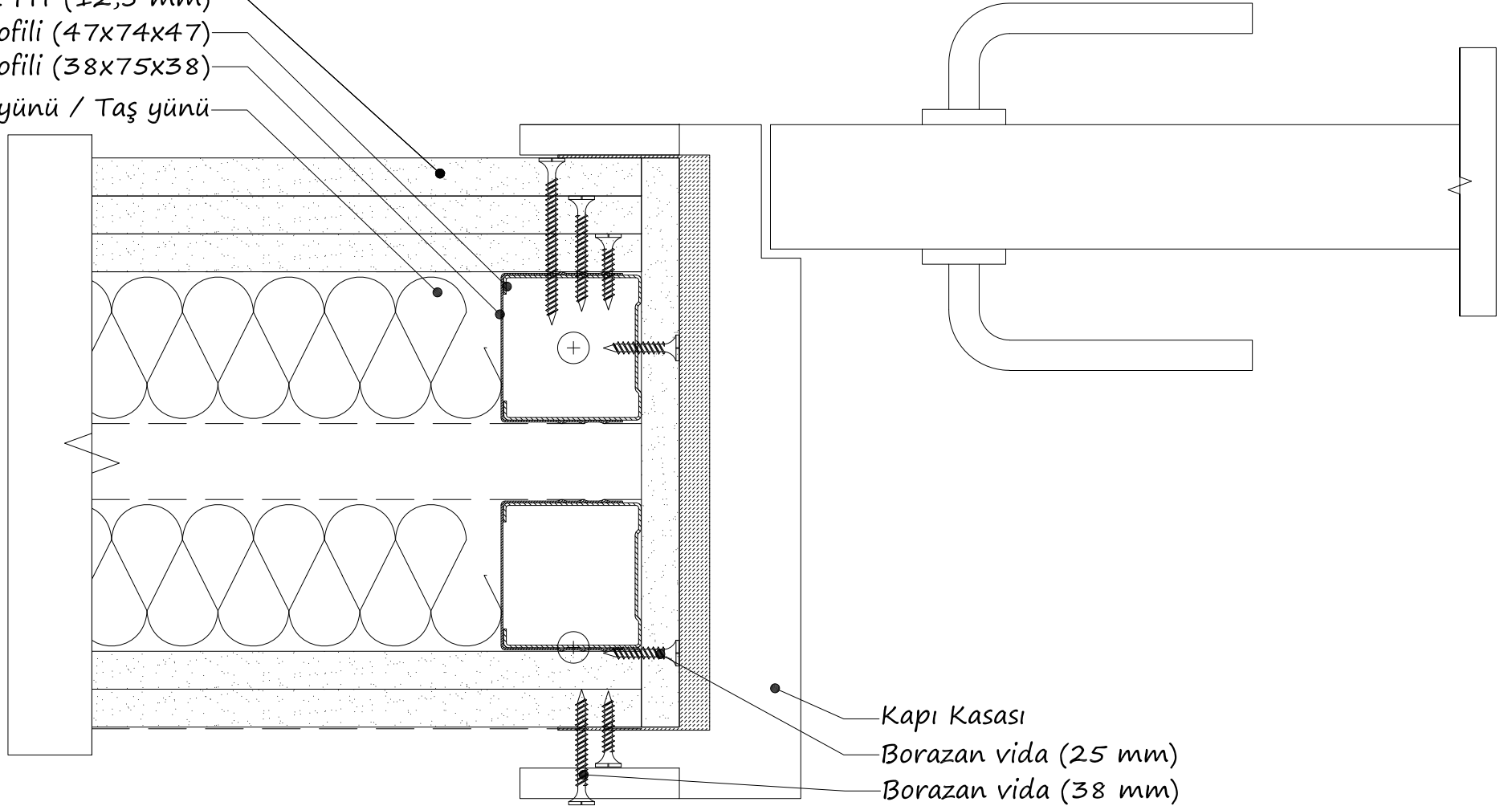

Kapi Kasası

Borazan vida (25 mm)

Borazan vida (38 mm)

ABS ALÇI

<https://www.absalci.com.tr>

Pafta Adı:

DETAY 10: ÇİFT İSKELET ASİMETRİK KAT INTREME  
FIT YAPIŞTIRMA KAPI PLANI (BAĞLANTISIZ)

Proje Numarası: ABS\_BD\_01\_18

Ölçek: 1/2

Çizen: ABS Alçı Design Ofis

Pafta: A4

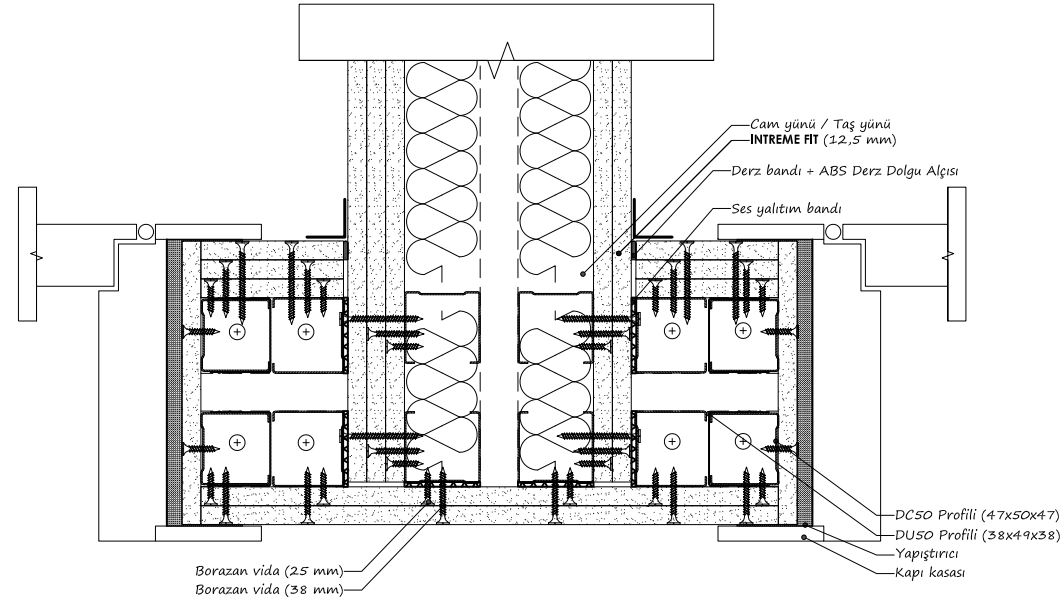

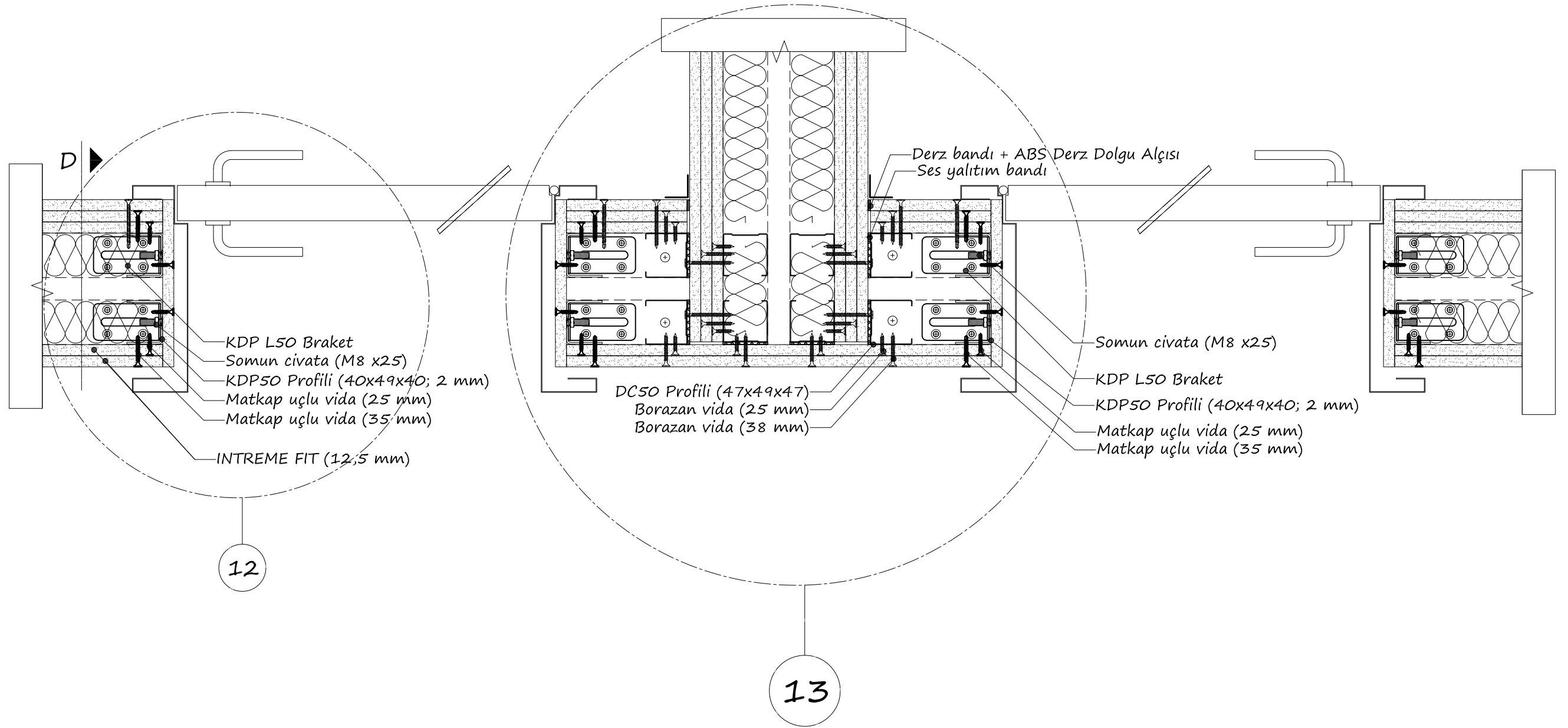

12

KDP50 Profili (40x49x40; 2 mm)

Kapı kanadı

KDP L50 Braket

Dübel - Vida / Çelik dübel

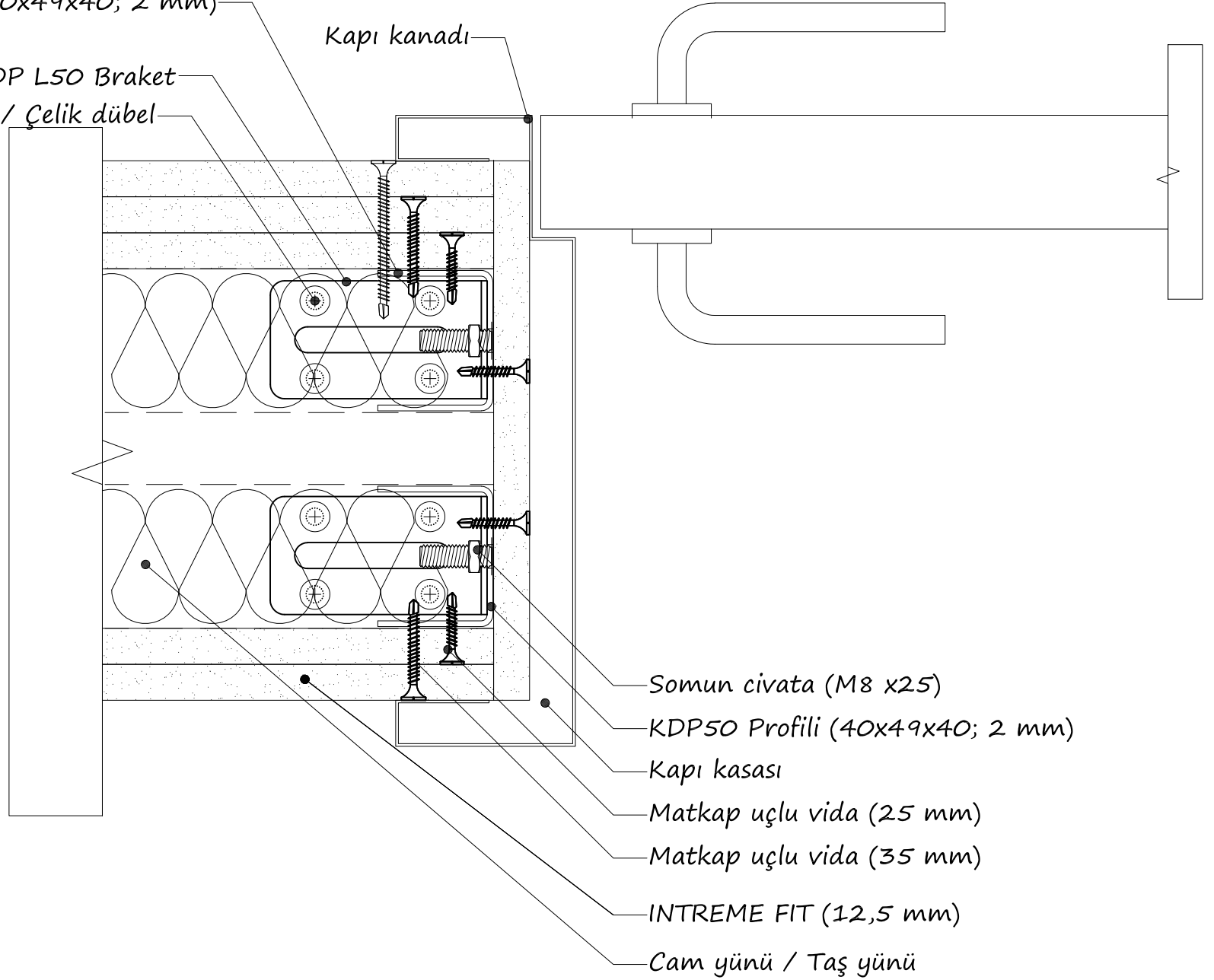

Somun civata (M8 x25)

KDP50 Profili (40x49x40; 2 mm)

Kapı kasası

Matkap uçlu vida (25 mm)

Matkap uçlu vida (35 mm)

INTREME FIT (12,5 mm)

Cam yünü / Taş yünü

