

01

ABS Derz Dolgu Alçısı

Delikli köşe profili
veya Köşe bandı +
ABS Derz Dolgu Alçısı

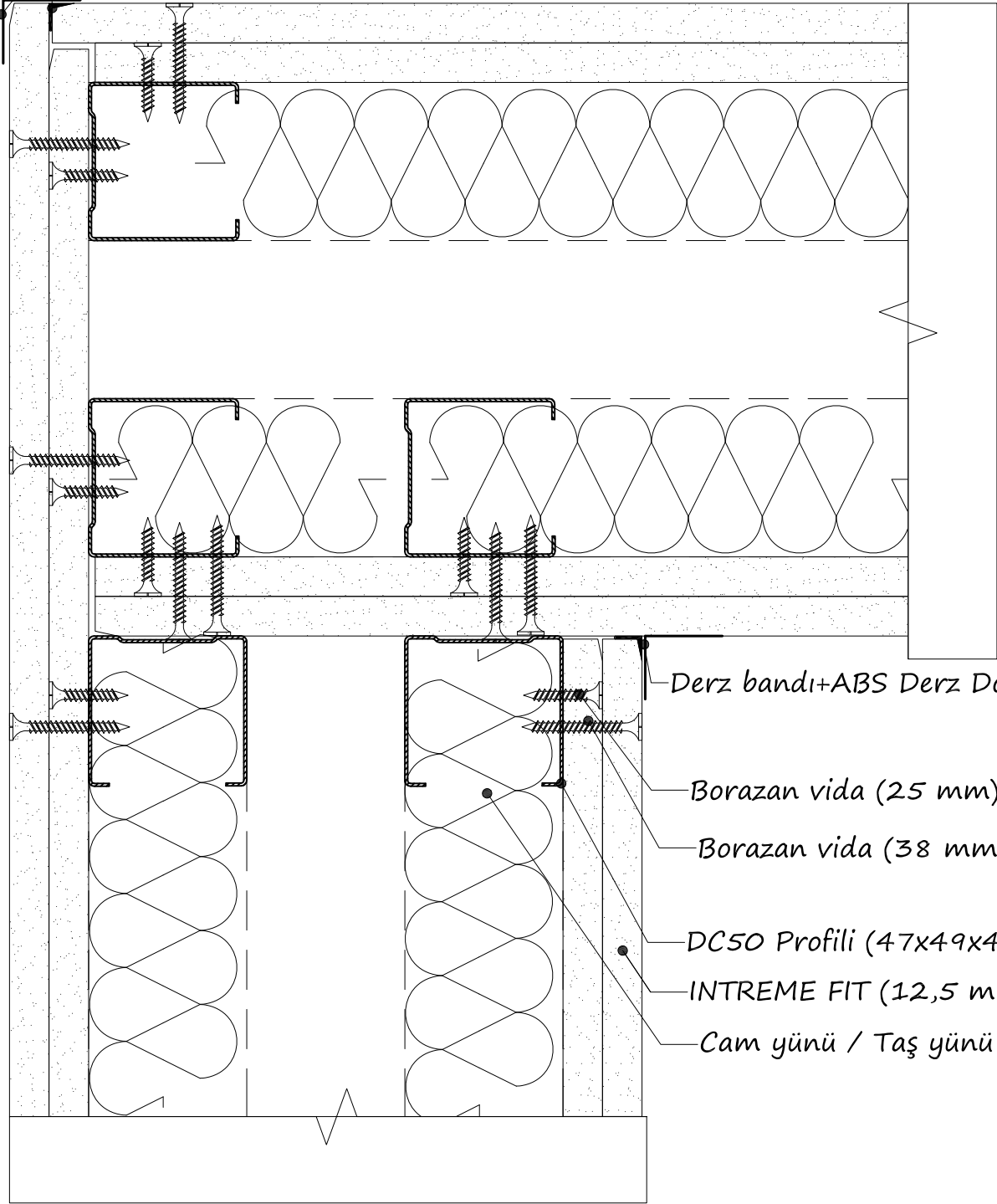

Derz bandı+ABS Derz Dolgu Alçısı

Borazan vida (25 mm)

Borazan vida (38 mm)

DC50 Profili (47x49x47)

INTREME FIT (12,5 mm)

Cam yünü / Taş yünü

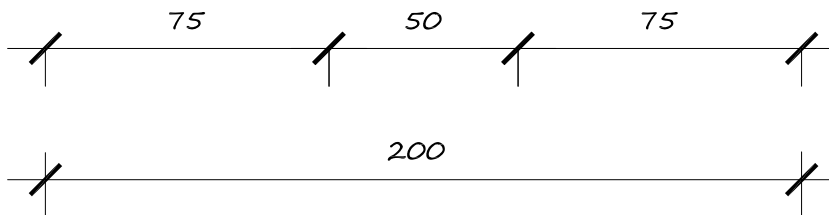

02

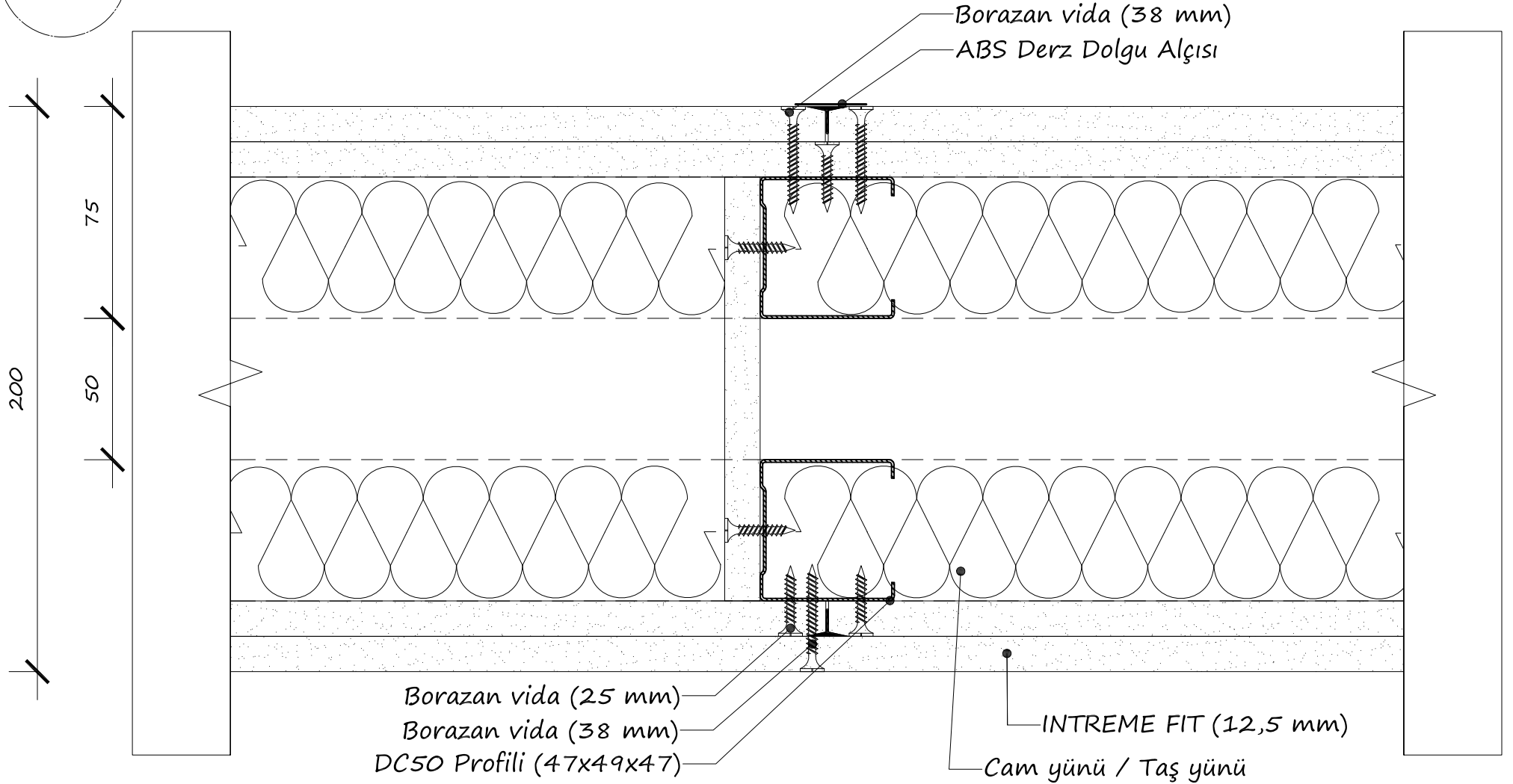

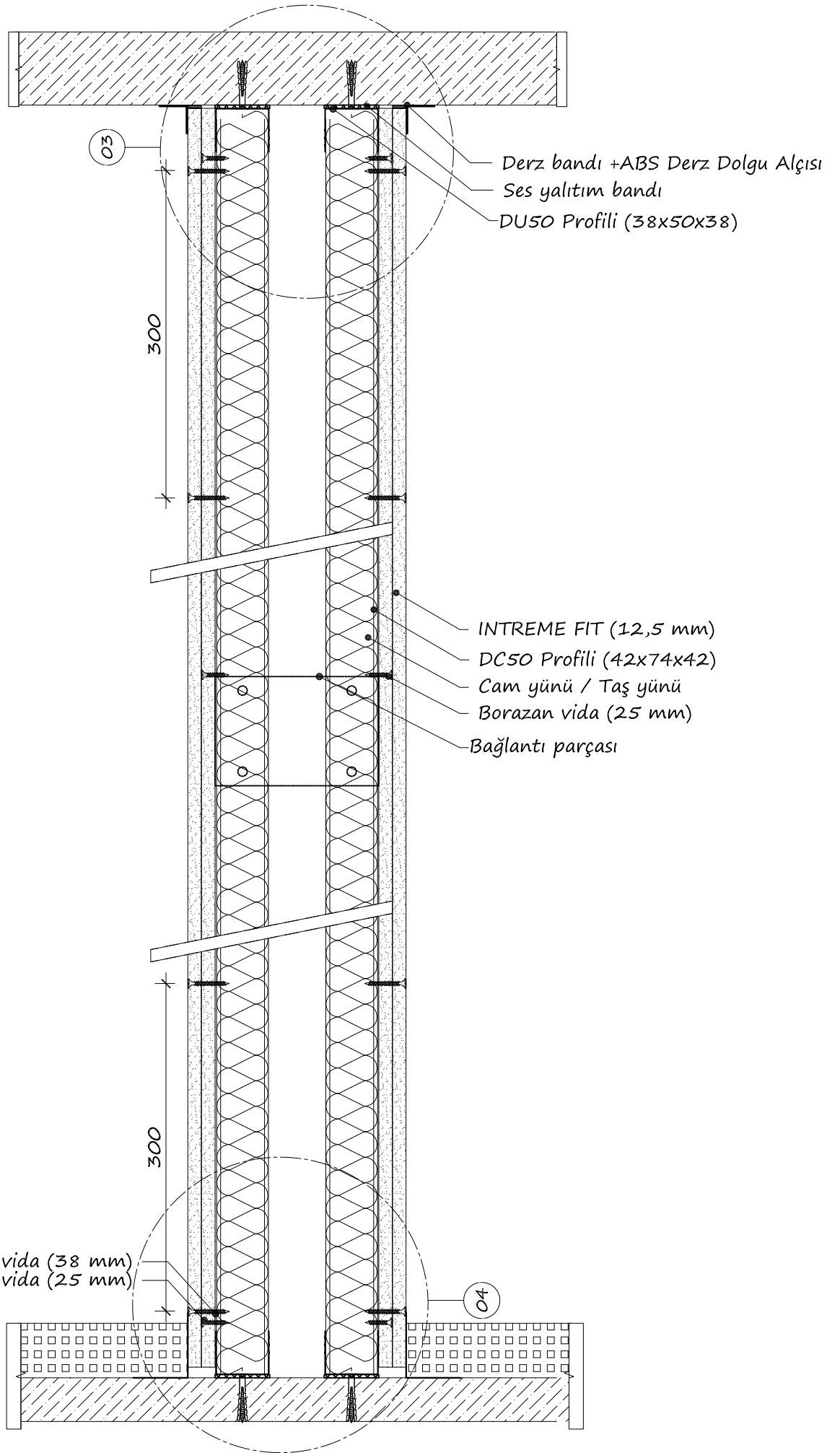

03

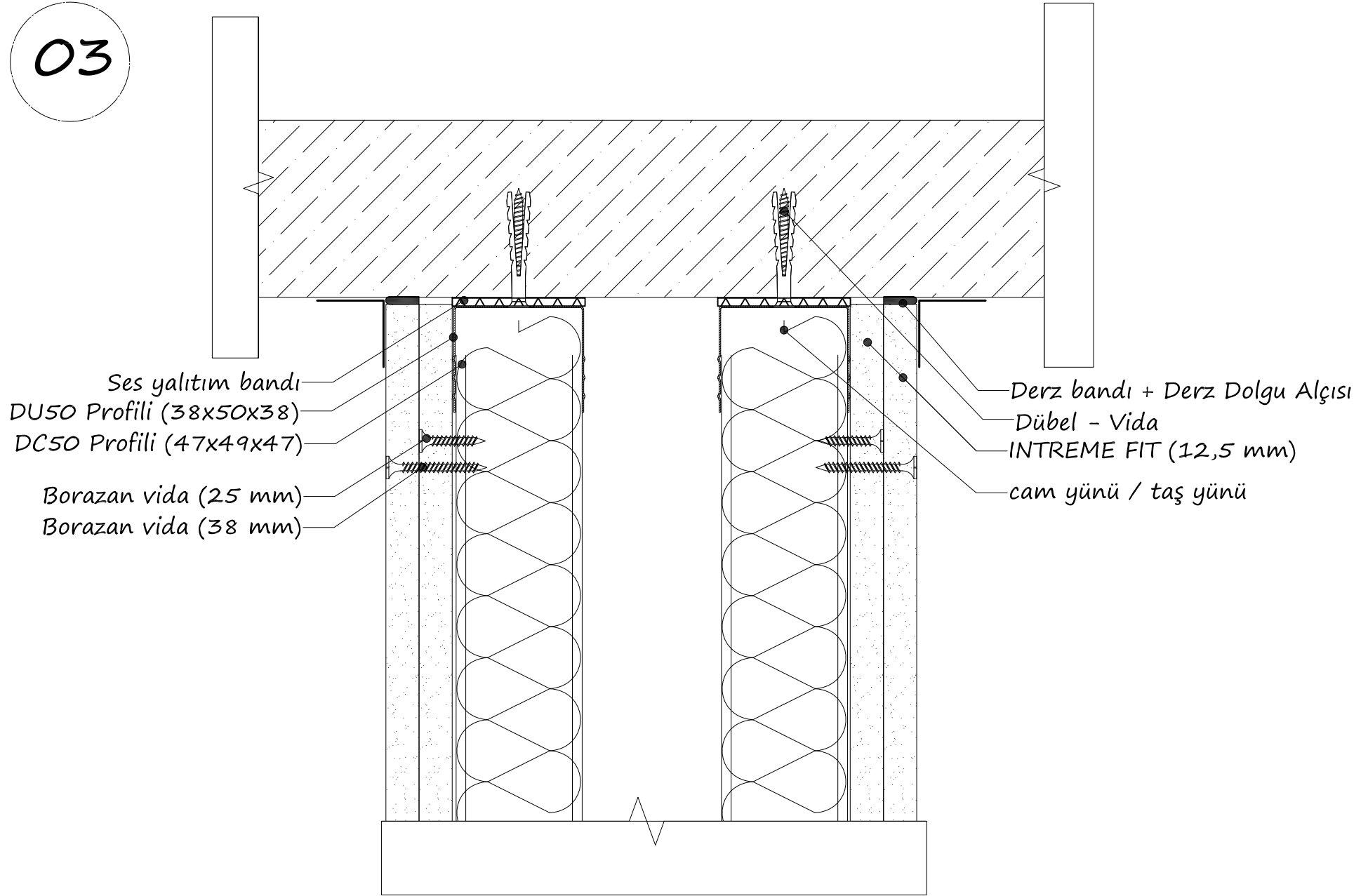

04

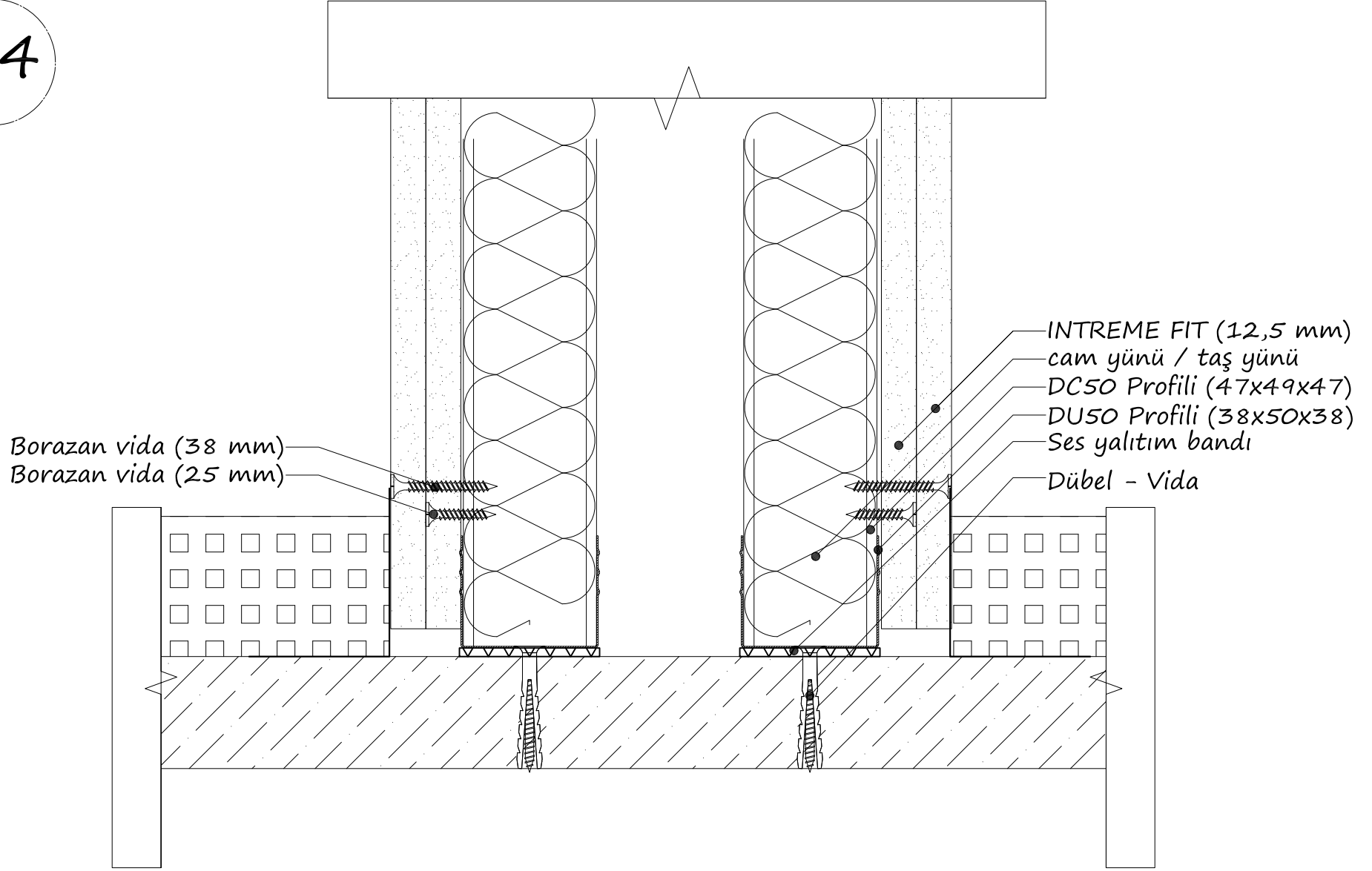

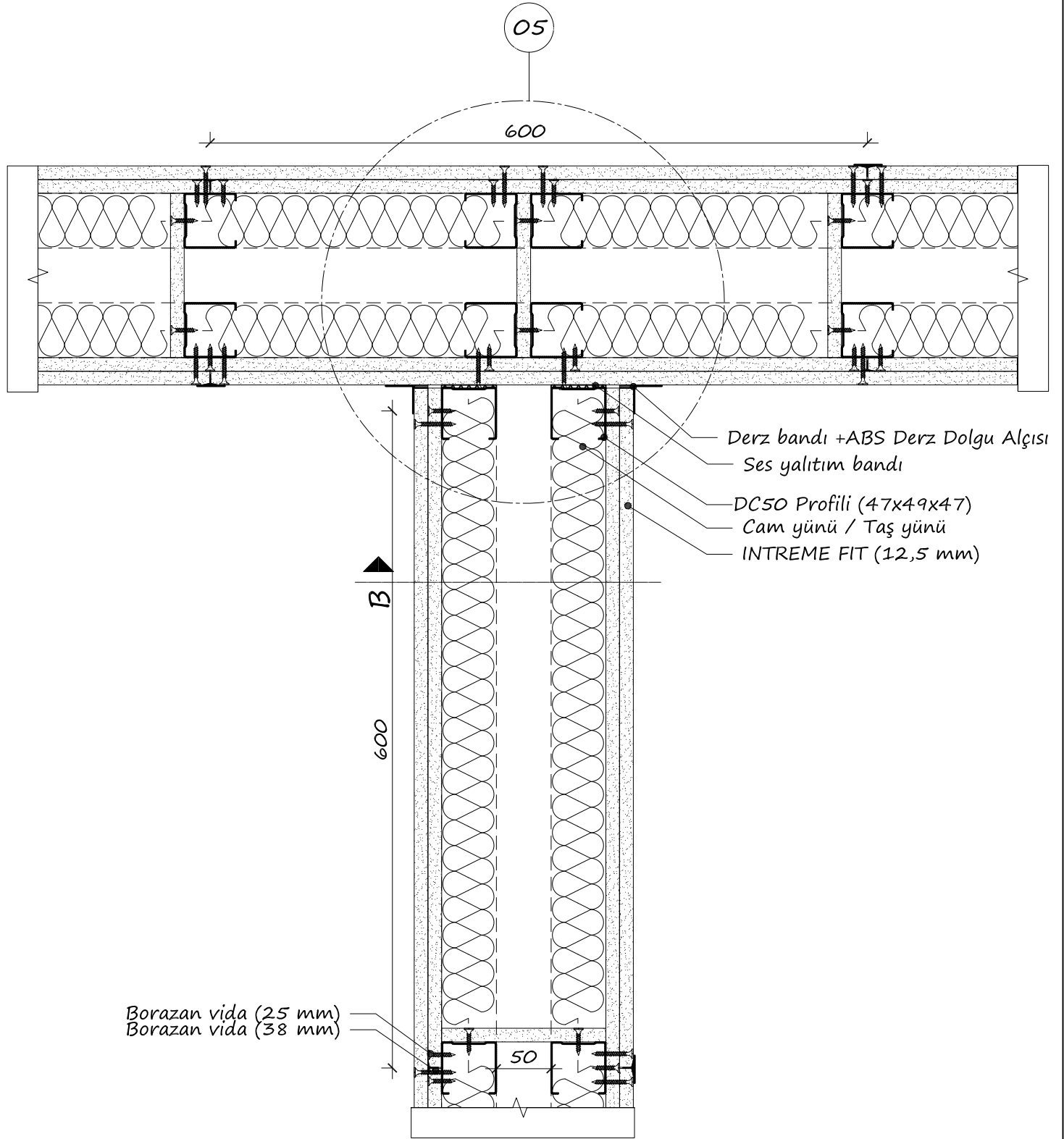

05

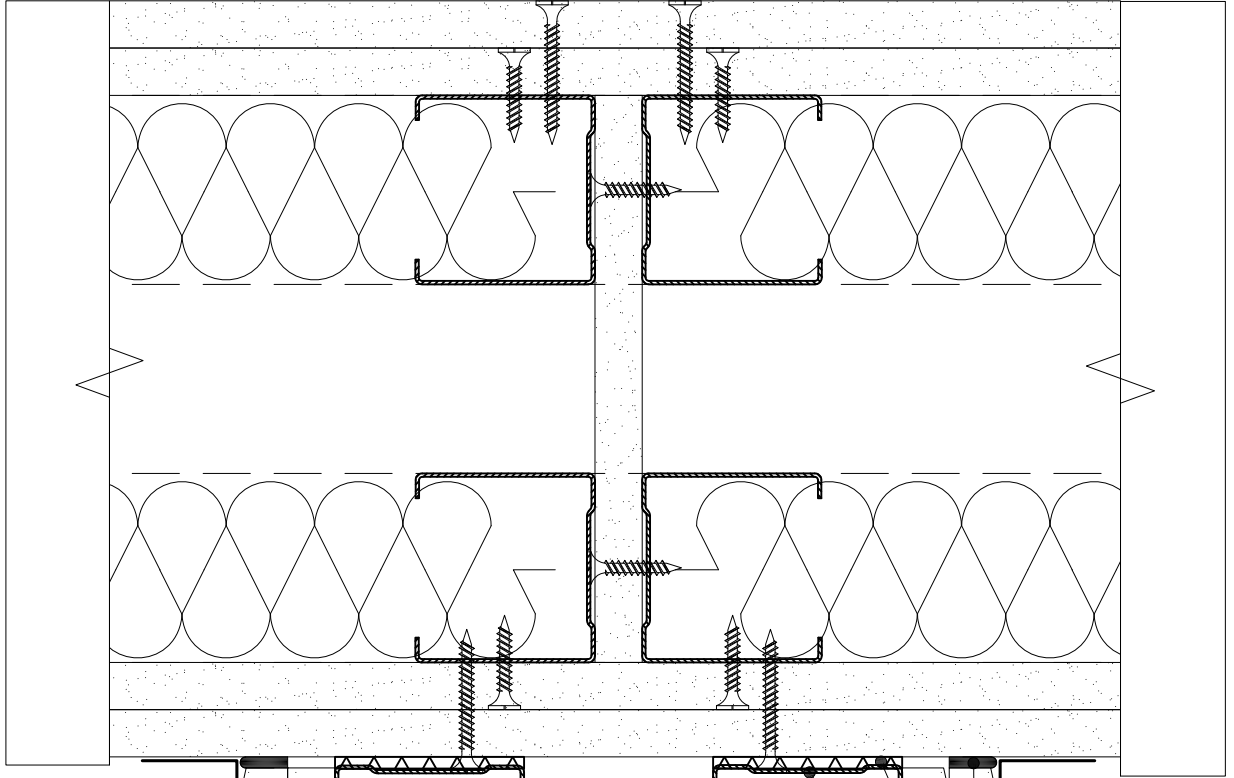

Borazan vida (25 mm)

Borazan vida (38 mm)

INTREME FIT (12,5 mm)

Derz bandı+ABS
Derz Dolgu Alçısı

Ses yalıtım bandı

DC50 Profili
(47x49x47)

Cam yünü/Taş yünü

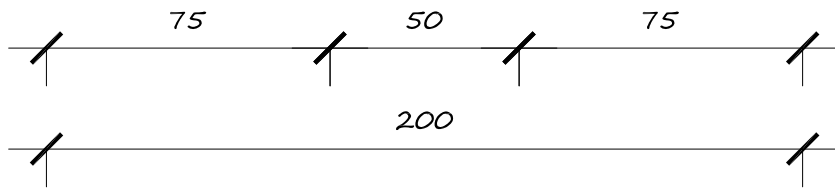

ABS ALÇI
<https://www.absalci.com.tr>

Pafta Adı: DETAY 05: ÇİFT İSKELET SİSTEMİ
BİRLEŞİM PLANI (BAĞLANTILI)

Proje Numarası: ABS_BD_02_08

Ölçek: 1/2

Çizen: ABS Alçı Design Ofis

Pafta: A4

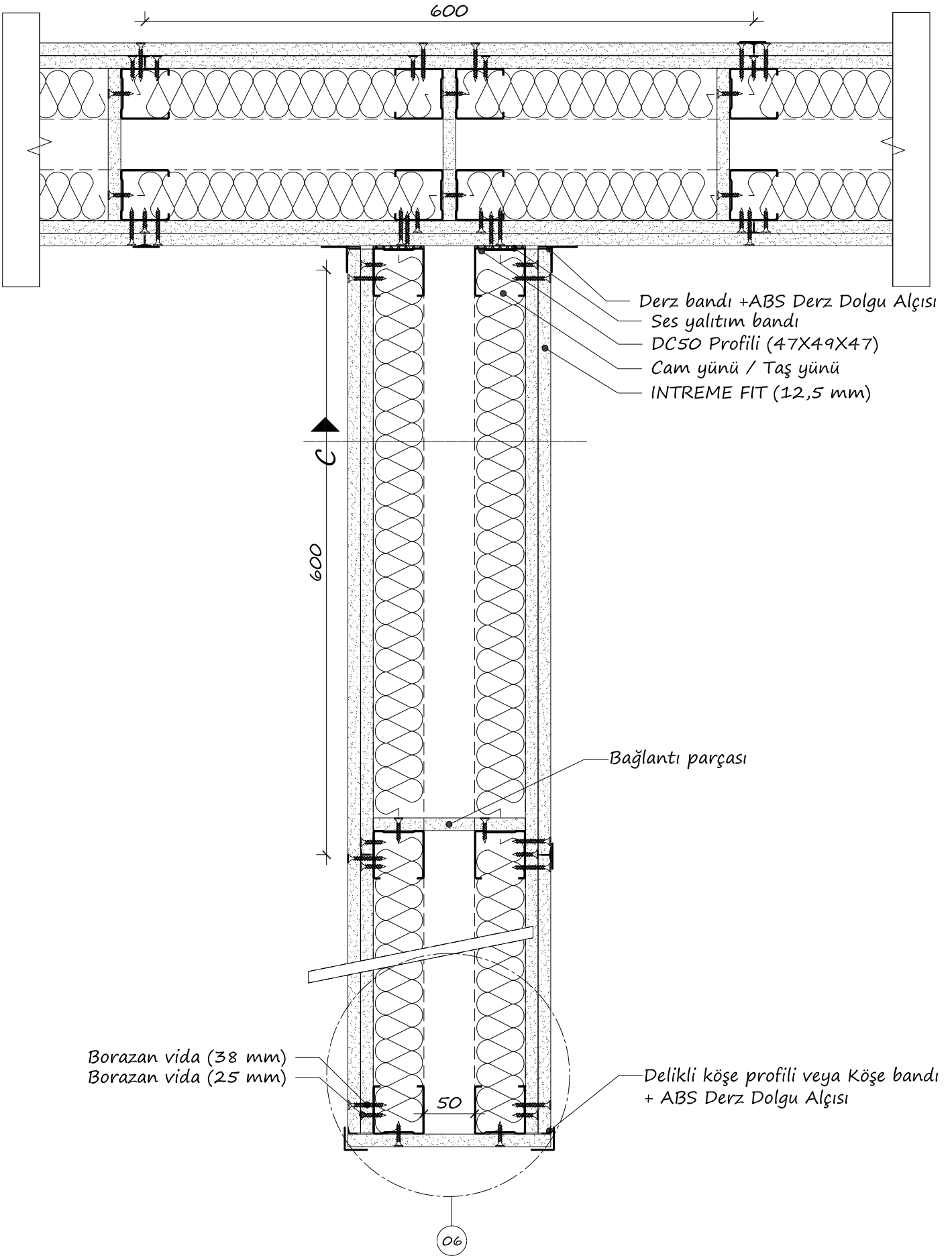

06

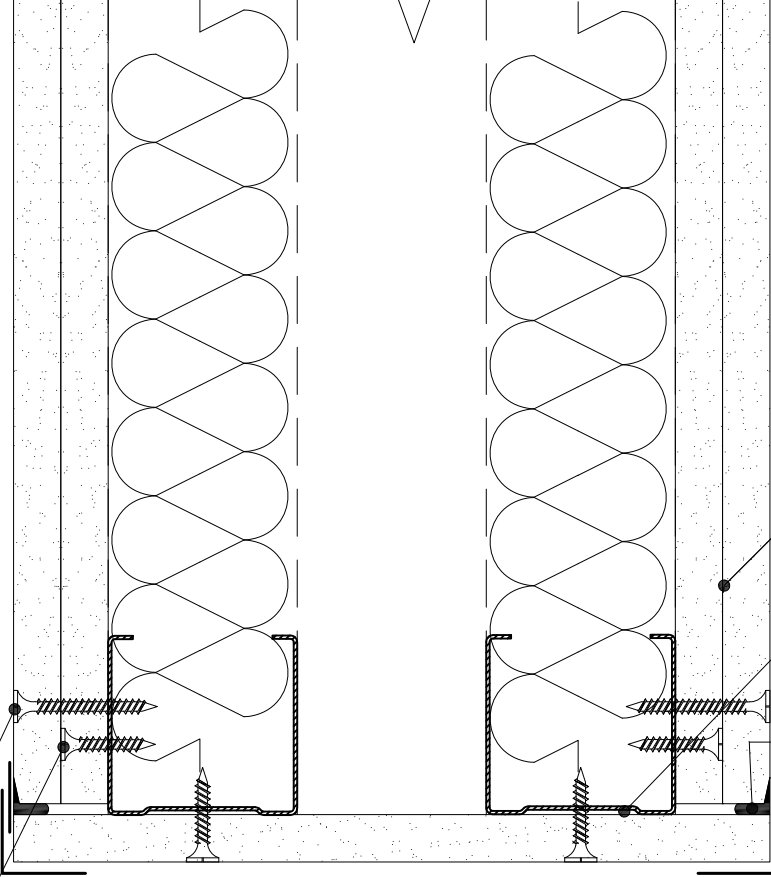
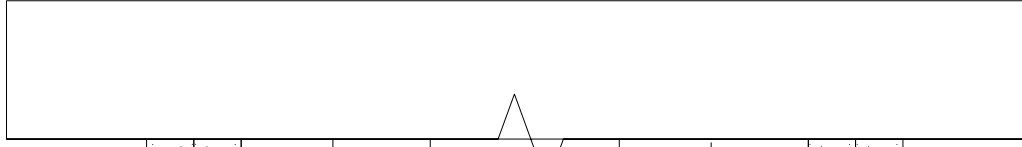
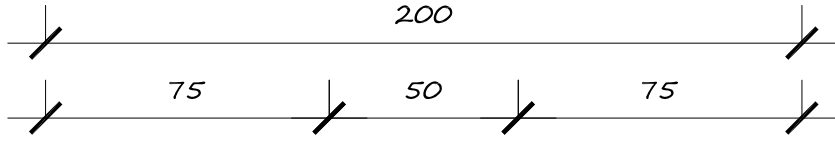

INTREME FIT
(12,5 mm)

DC50 Profili
(47x49x47)

Derz bandı+
ABS Derz Dolgu Alçısı

Borazan vida (25 mm)

Borazan vida (38 mm)

Delikli köşe profili veya Köşe bandı
+ ABS Derz Dolgu Alçısı

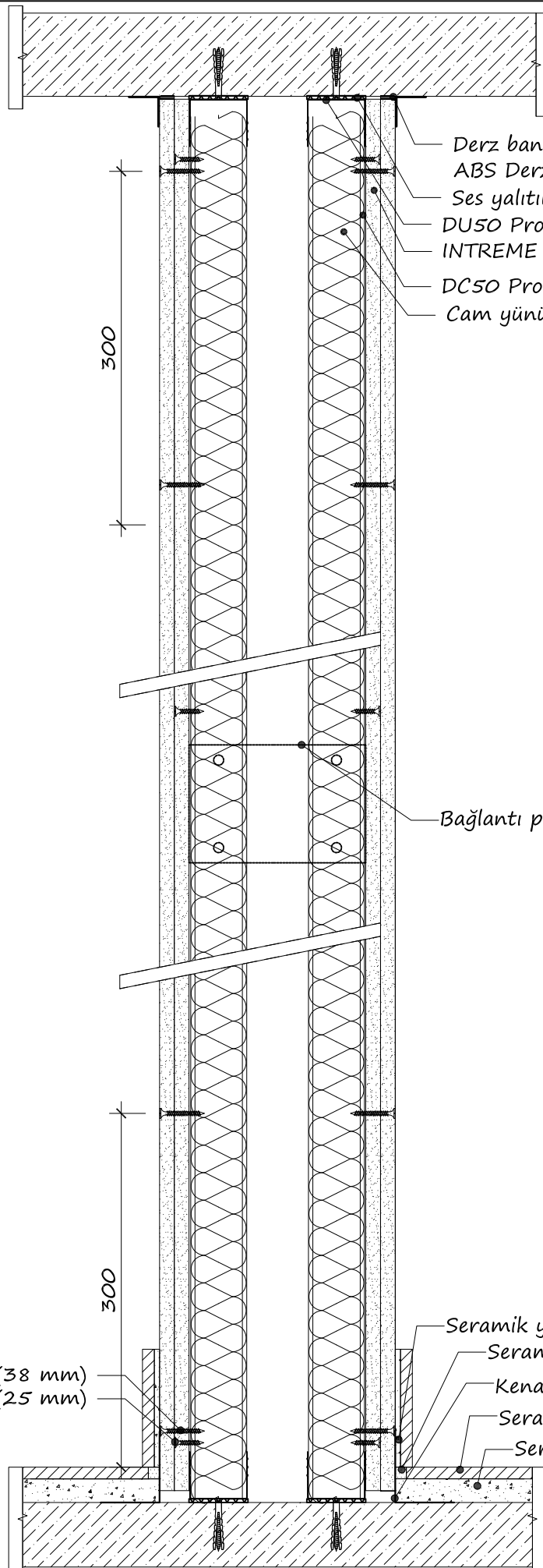

Derz bandı+
ABS Derz Dolgu Alçısı
Ses yalıtım bandı
DU50 Profili (38x50x38)
INTREME FIT (12,5 mm)
DC50 Profili (47x49x47)
Cam yünü / Taş yünü

Bağlantı parçası

Borazan vida (38 mm)
Borazan vida (25 mm)

Seramik yapıştırıcısı + Seramik süpügelik
Seramik derz dolgusu
Kenar bandı
Seramik
Seramik yapıştırıcısı

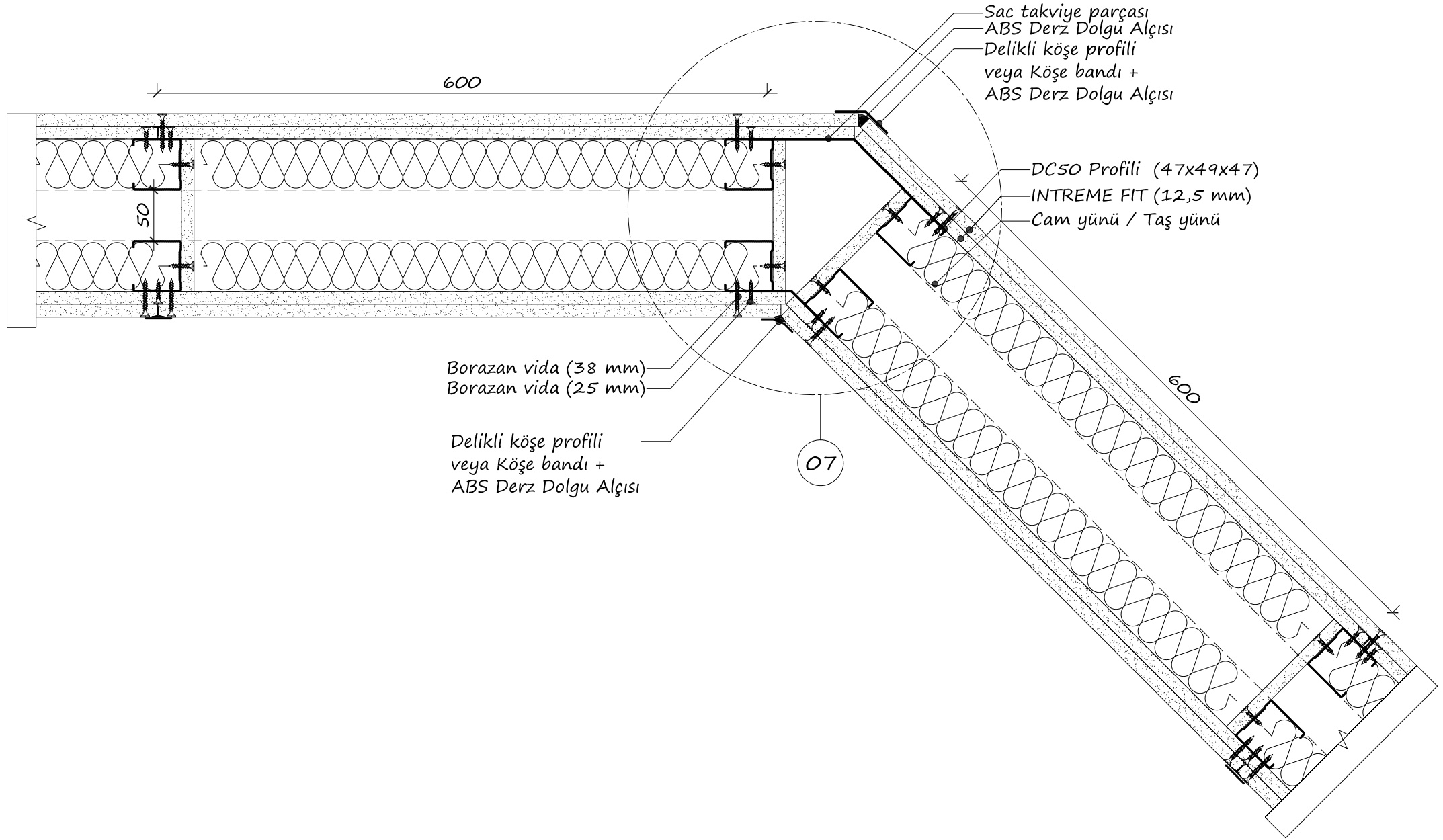

07

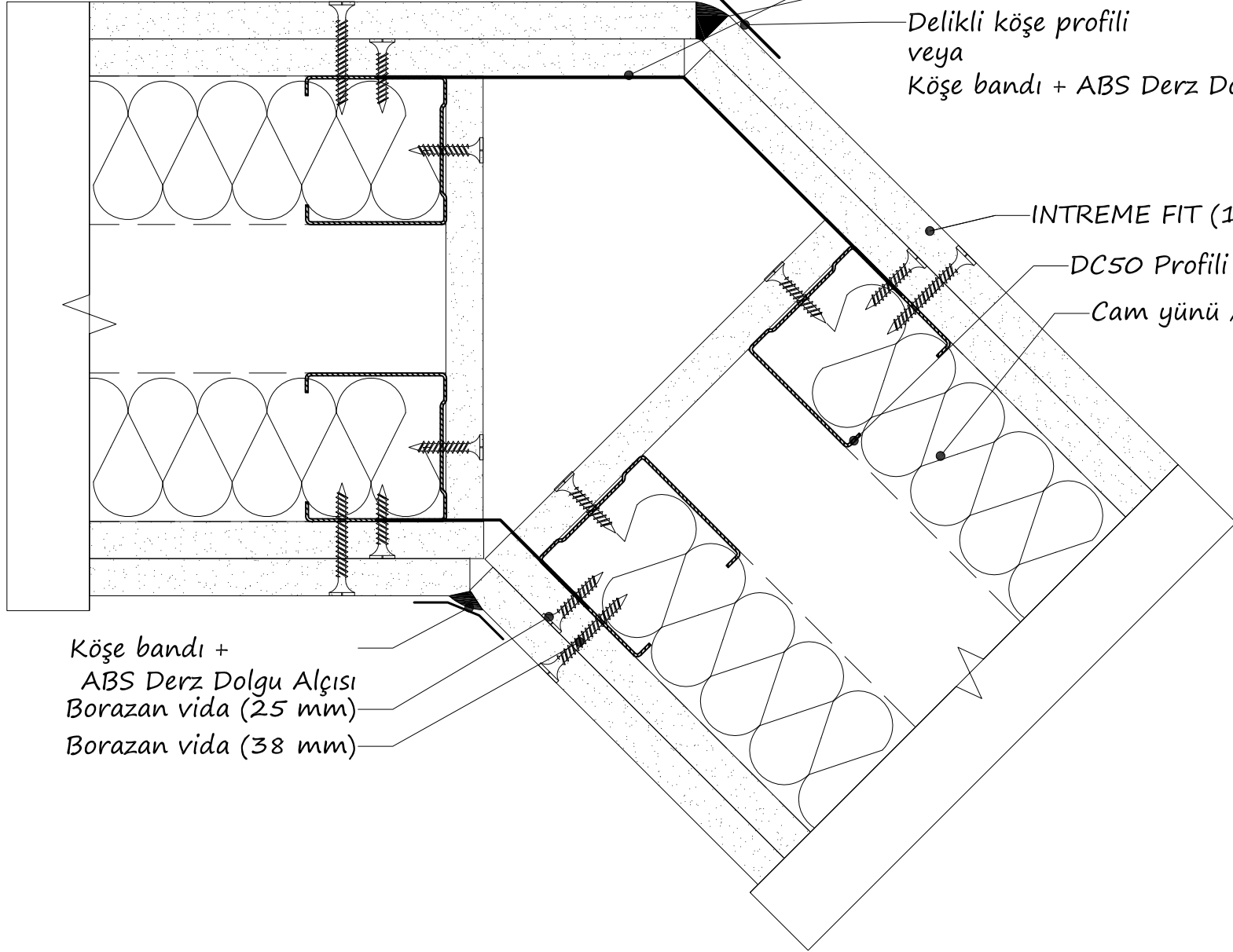
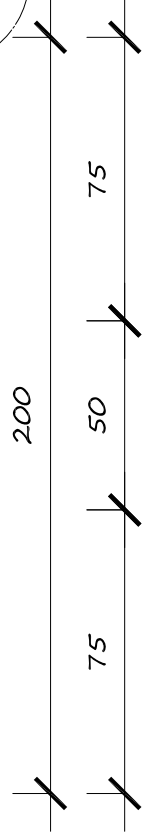

Sac takviye parçası
ABS Derz Dolgu Alçısı
Delikli köşe profili
veya
Köşe bandı + ABS Derz Dolgu Alçısı

INTREME FIT (12,5 mm)

DC50 Profili (47x49x47)

Cam yünü / Taş yünü

Köşe bandı +
ABS Derz Dolgu Alçısı
Borazan vida (25 mm)
Borazan vida (38 mm)

ABS ALÇI
<https://www.absalci.com.tr>

Pafta Adı:

DETAY 07: ÇİFT İSKELET SİSTEMİ
135° DUVAR BİRLEŞİMİ (BAĞLANTILI)

Proje Numarası: ABS_BD_02_13

Ölçek: 1/2

Çizen: ABS Alçı Design Ofis

Pafta: A4

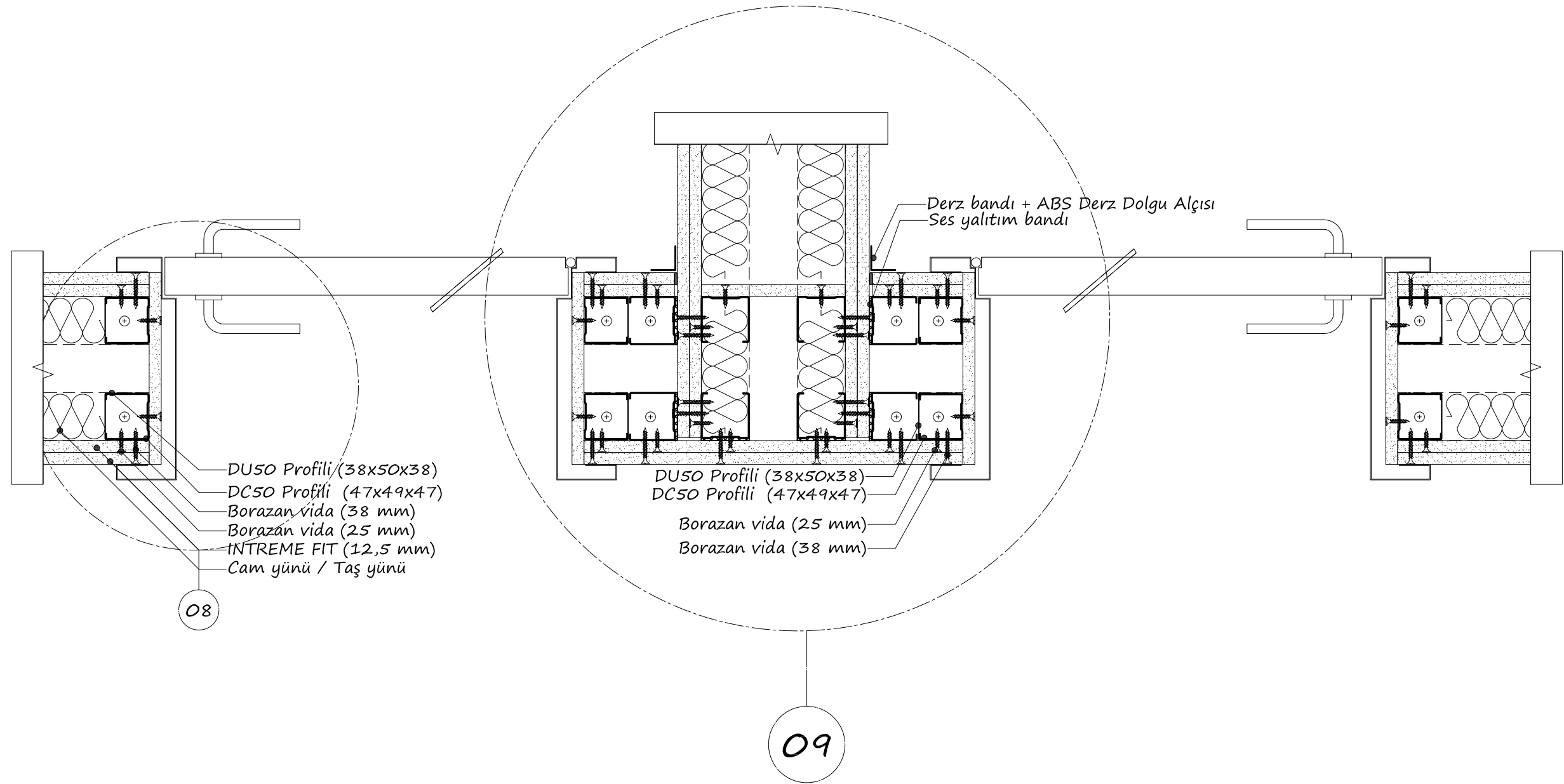

08

INTREME FIT (12,5 mm)
DC50 Profili (47x49x47)
DU50 Profili (38x50x38)
Cam yünü / Taş yünü

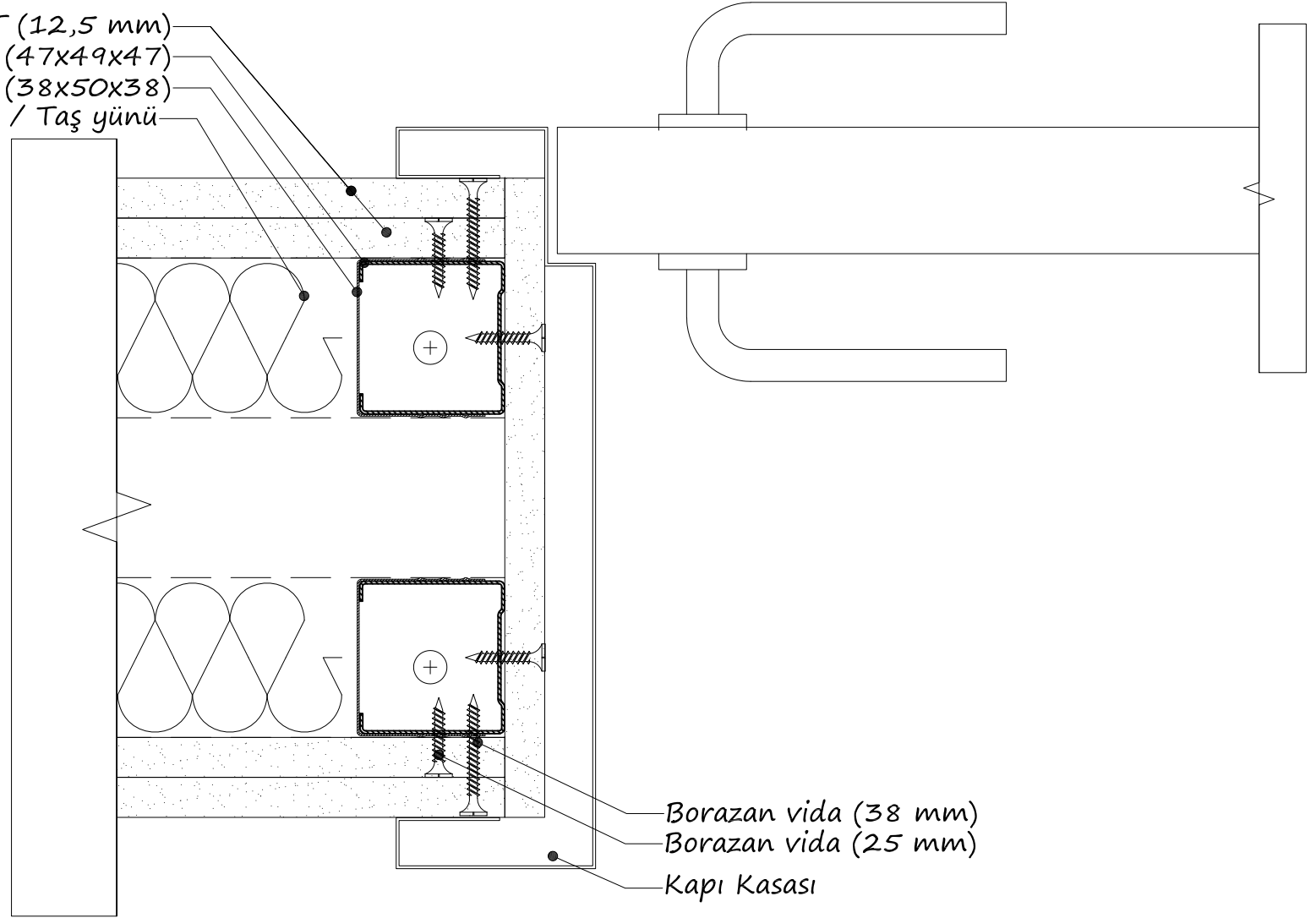

Borazan vida (38 mm)

Borazan vida (25 mm)

Kapı Kasası

ABS ALÇI
<https://www.absalci.com.tr>

Pafta Adı:

DETAY 08: ÇİFT İSKELET ÇİFT KAT INTREME FIT
VİDALAMALI KAPI PLANI (BAĞLANTILI)

Proje Numarası: ABS_BD_02_15

Ölçek: 1/2

Çizen: ABS Alçı Design Ofis

Pafta: A4

09

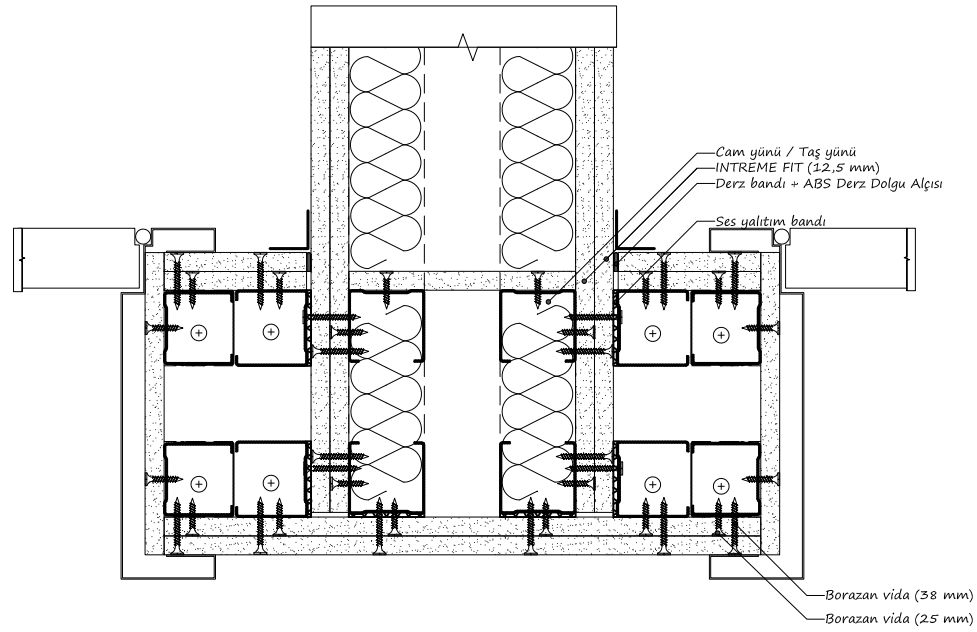

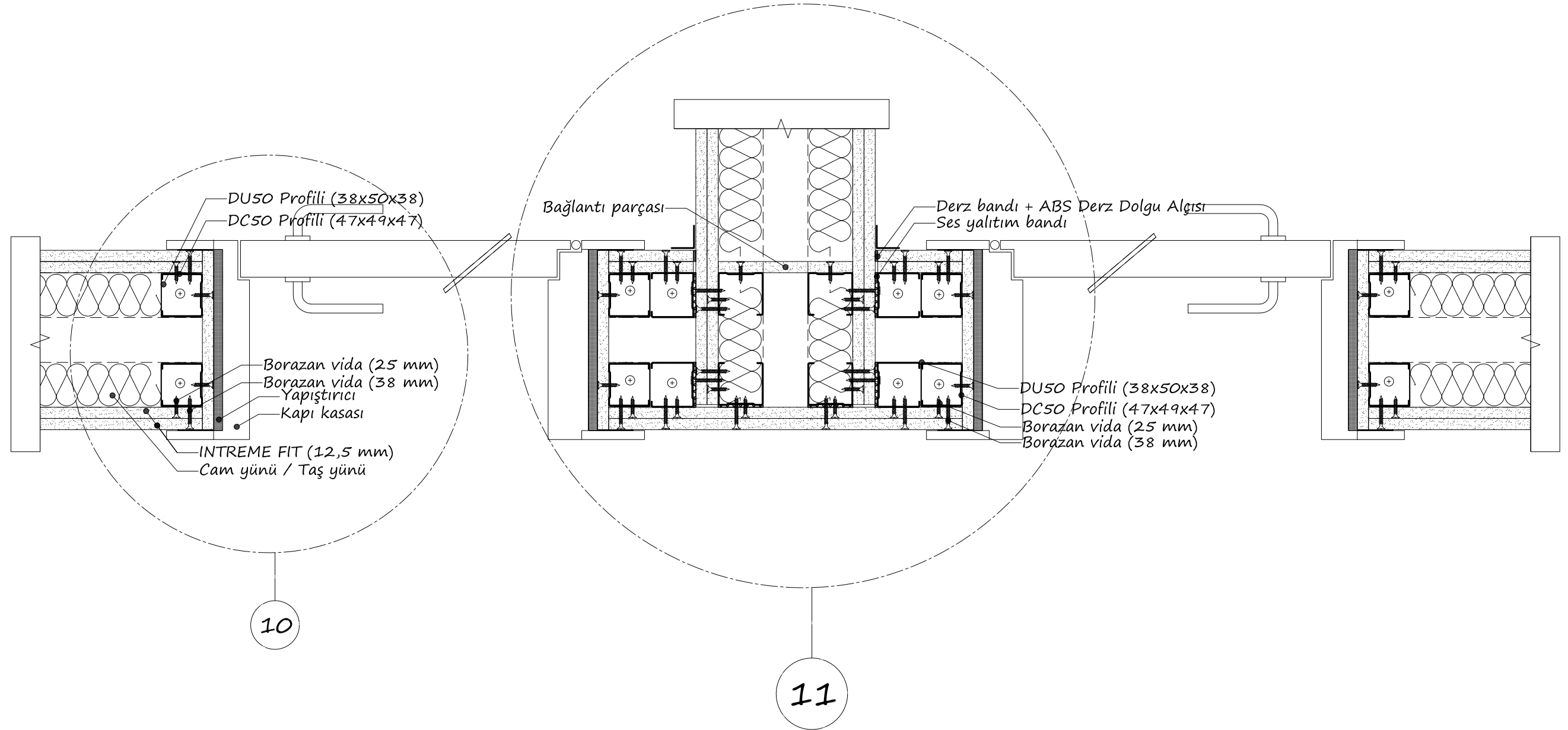

10

INTREME FIT (12,5 mm)
DC50 Profili (47x49x47)
DU50 Profili (38x50x38)
Cam yünü / Taş yünü

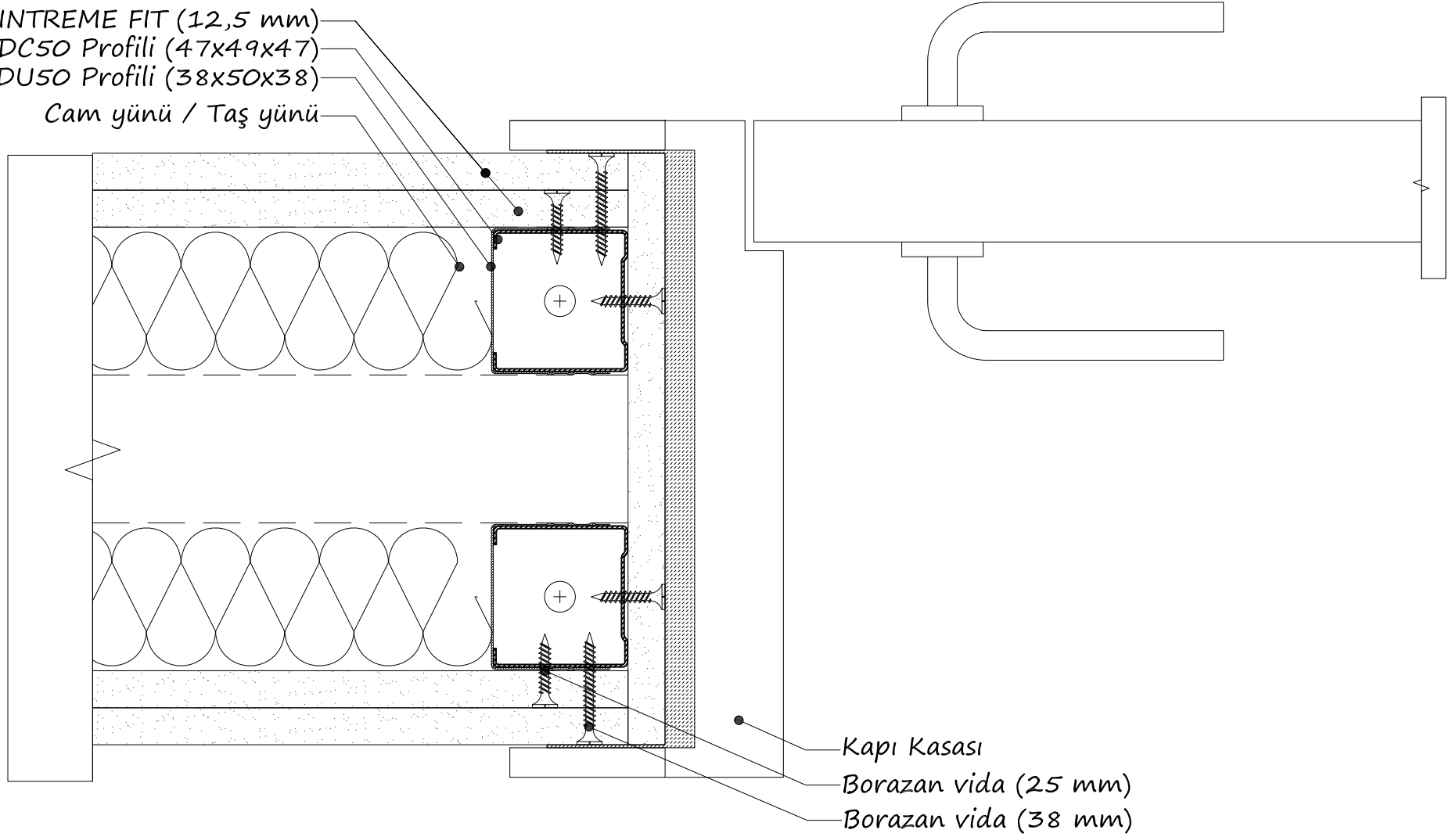

Kapı Kasası

Borazan vida (25 mm)

Borazan vida (38 mm)

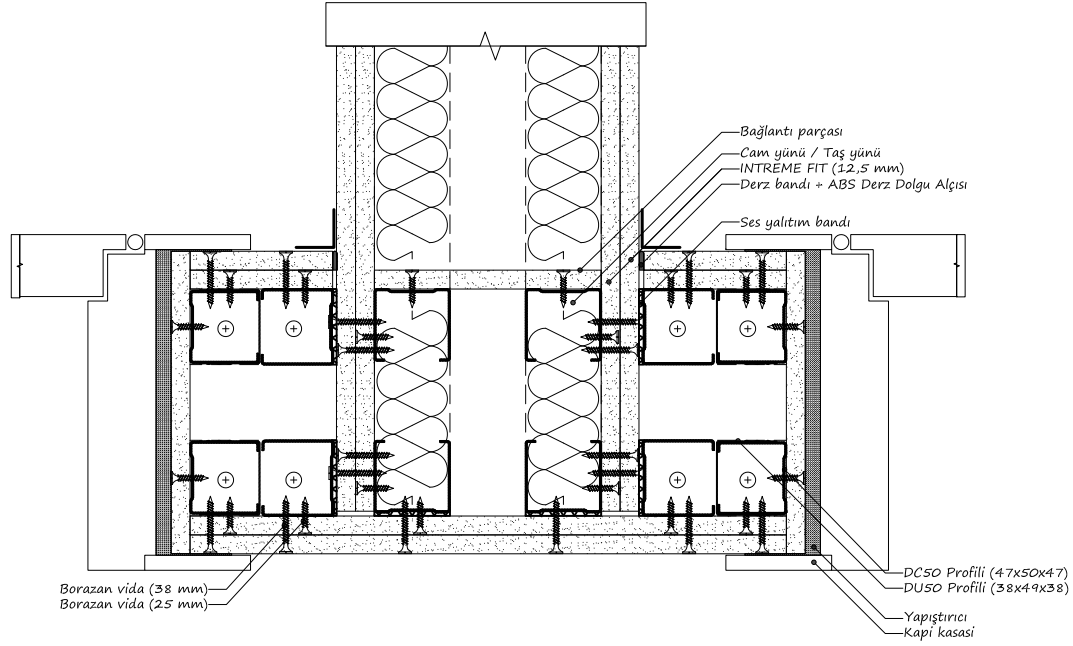

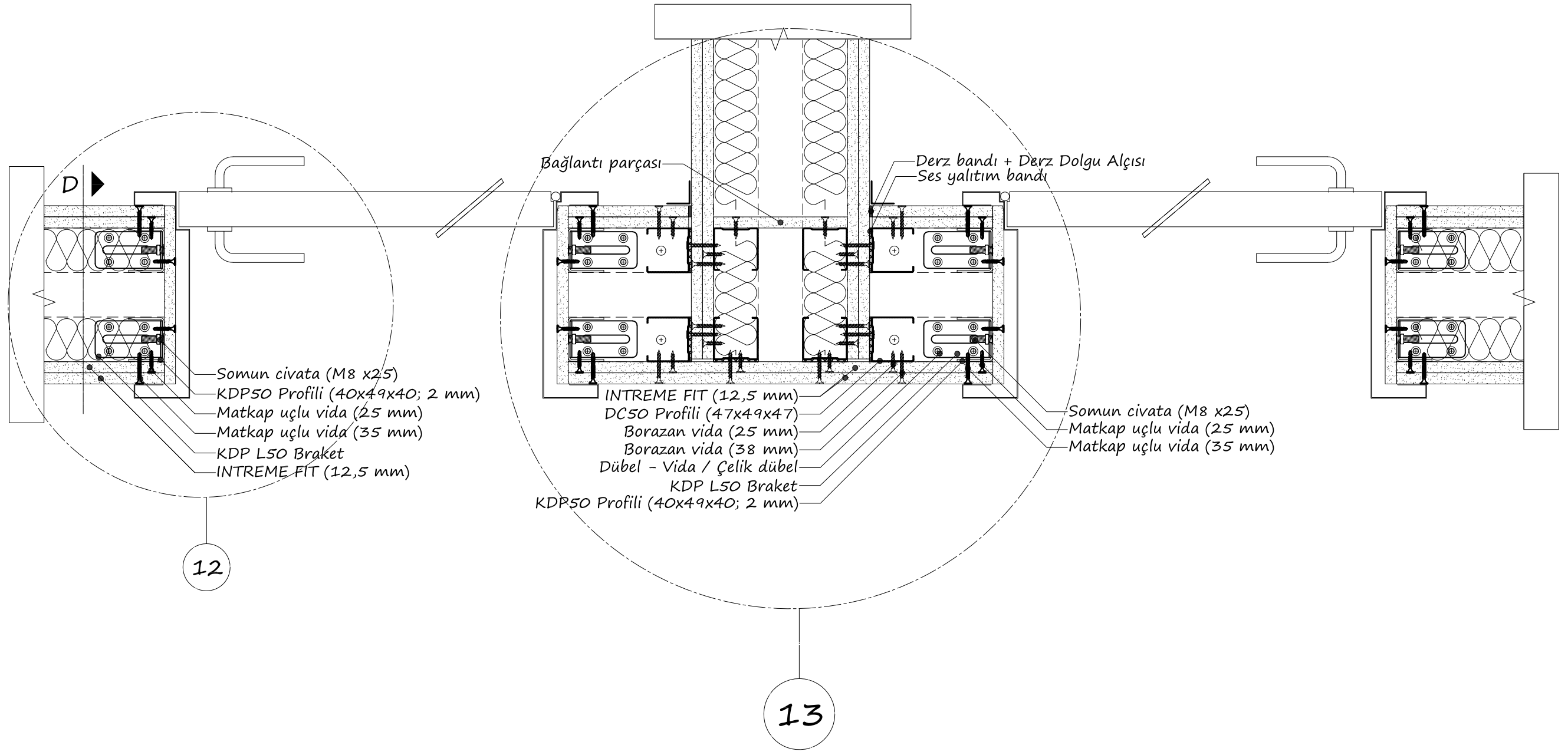

12

KDP50 Profili (40x49x40; 2 mm)

Kapı kanadı

KDP L50 Braket

Dübel - Vida / Çelik dübel

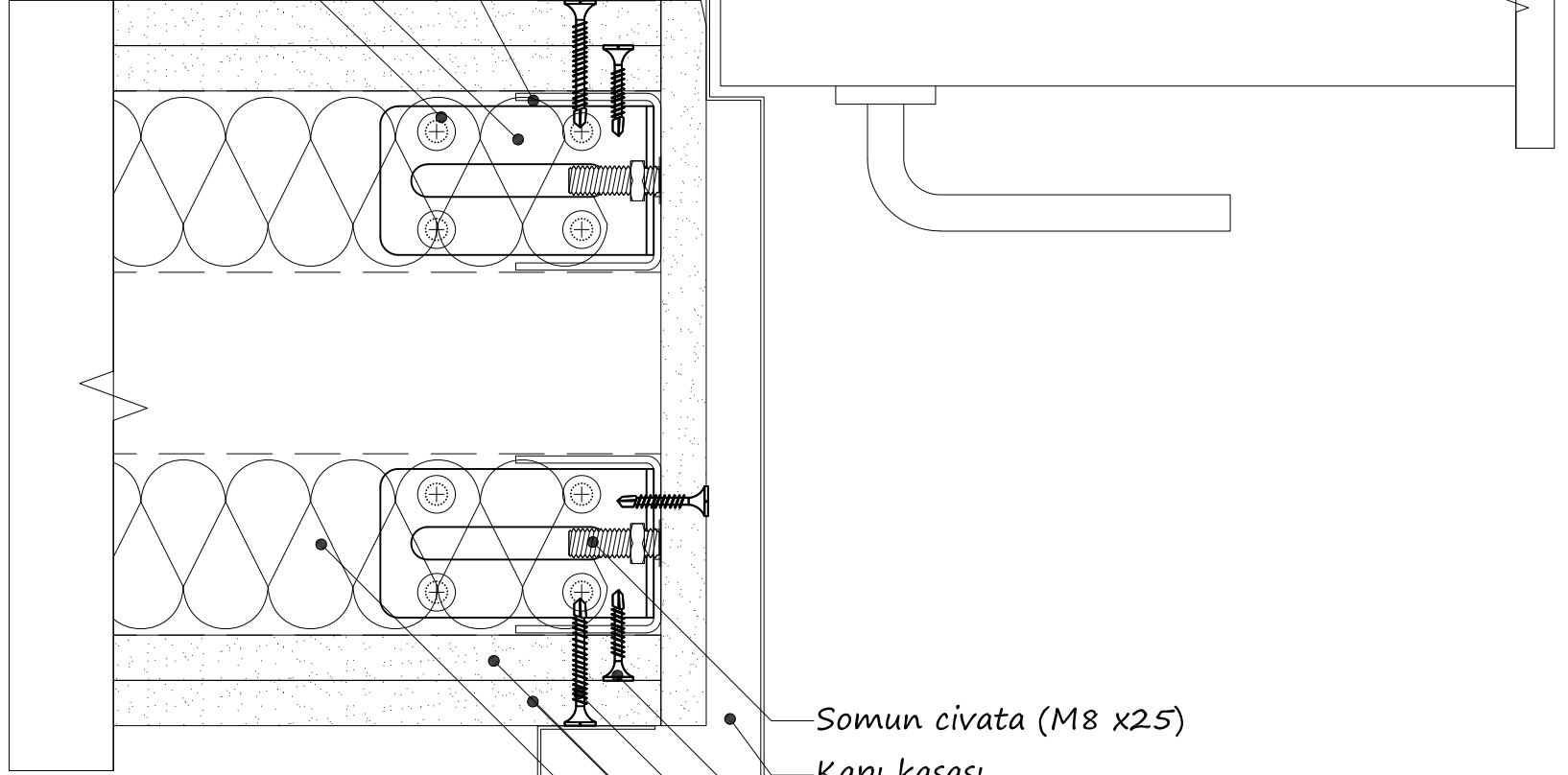

Somun civata (M8 x25)

Kapı kasası

Matkap uçlu vida (25 mm)

Matkap uçlu vida (35 mm)

INTREME FIT (12,5 mm)

cam yünü / taş yünü

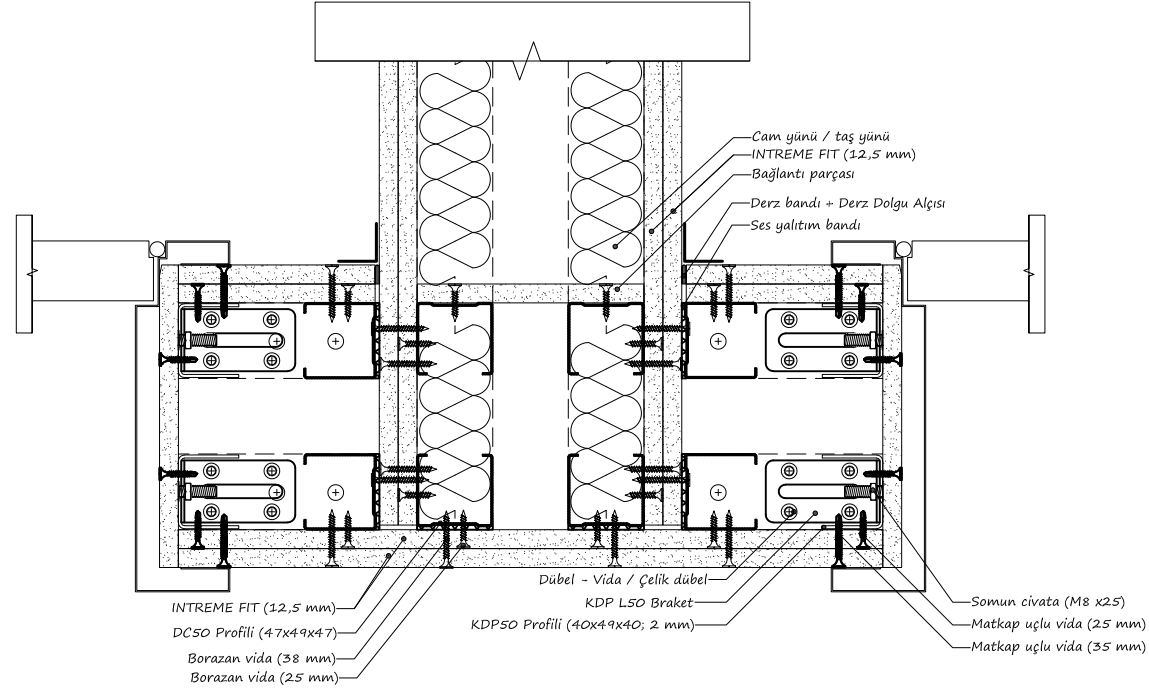

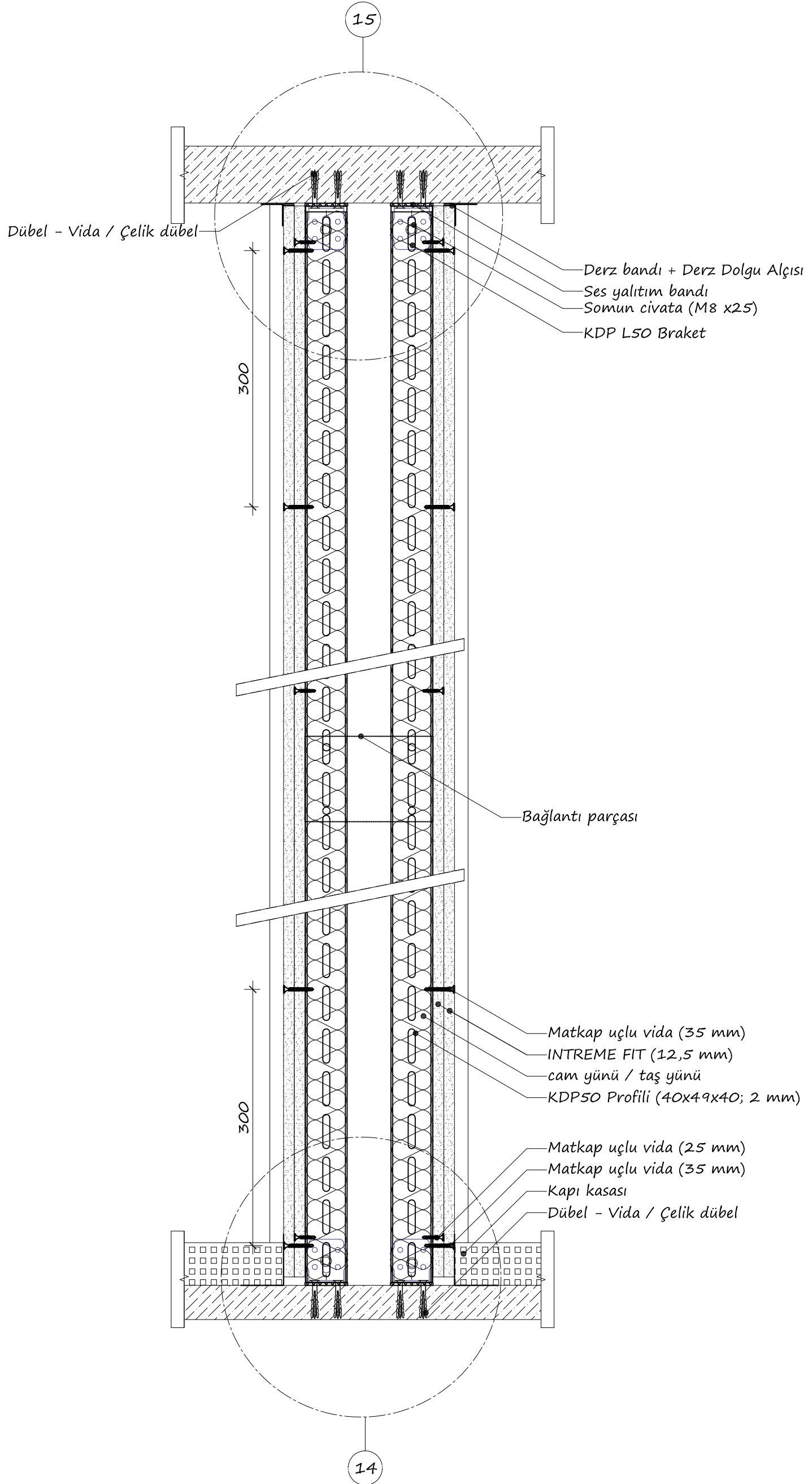

14

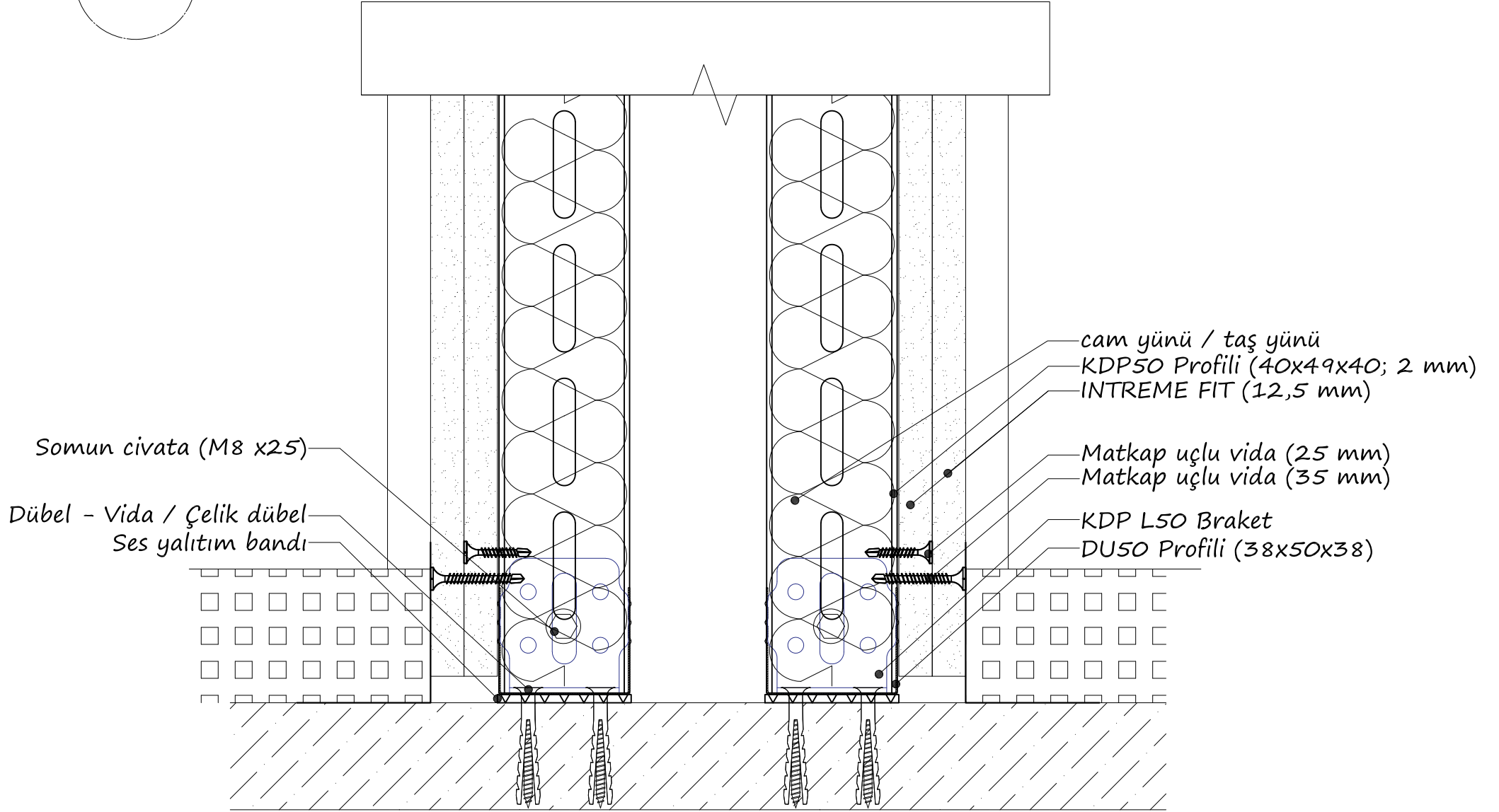

15

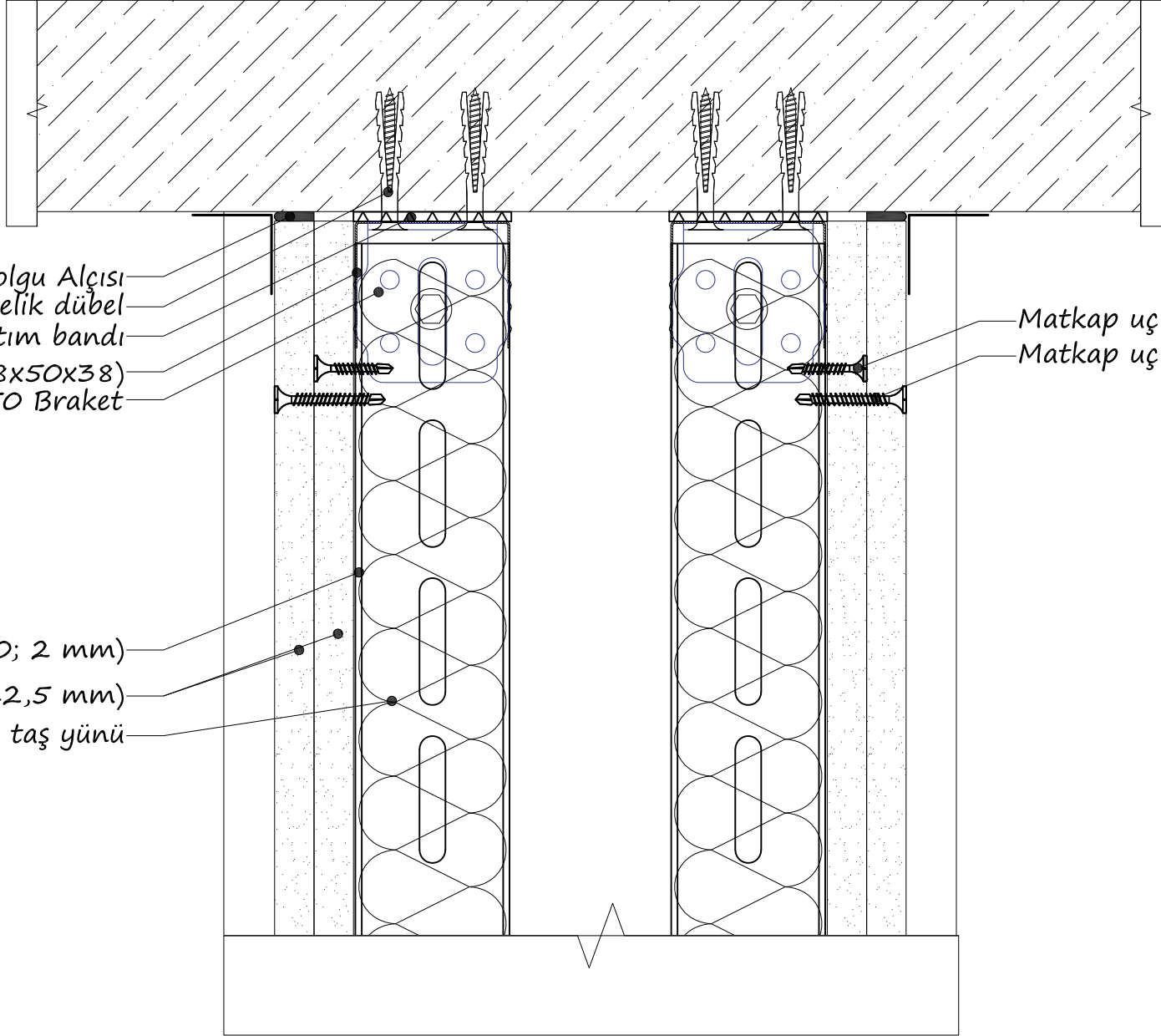

Derz bandı + Derz Dolgu Alçısı
Dübel - Vida / Çelik dübel
Ses yalıtım bandı
DU50 Profili (38x50x38)
KDP L50 Braket

Matkap uçlu vida (25 mm)
Matkap uçlu vida (35 mm)

KDP50 Profili (40x49x40; 2 mm)
INTREME FIT (12,5 mm)
cam yünü / taş yünü

ABS ALÇI
<https://www.absalci.com.tr>

Pafta Adı:

DETAY 15: ÇİFT İSKELET SİSTEMİ KAPI DESTEK
PROFİLİ TAVAN BİRLEŞİM KESİTİ (BAĞLANTILI)

Proje Numarası: ABS_BD_02_25

Ölçek: 1/2

Çizen: ABS Alçı Design Ofis

Pafta: A4

